

**Overview**

The flow measuring principle is based on the Coriolis Effect. The FCS400 sensor's measuring tubes are energized by an electro-mechanical driver circuit which oscillates them at their resonance frequency.

Two pick-ups are placed symmetrically upstream and downstream of the central driver. When a process fluid passes through the sensor, the Coriolis Effect will act on the vibrating tubes and cause deflection which can be measured as a phase shift between pick-ups 1 and 2. The phase shift is proportional to the mass flow rate.

The amplitude of the driver is automatically regulated to ensure a stable output from both of the pickups.

The temperatures of the sensor tubes and frame are measured with high precision to provide compensation for changes with temperature in the measuring properties.

The sensor signals are analyzed for flow, density and fluid temperature in the sensor front end. The digital signal is controlled to conform to high Safety Integrated Level (SIL) and sent digitally to the transmitter via standard cable. The FCT030 further calculates total mass and volume, fraction, dosing control and many other functions.

The front-end module has a process noise filter, which can be used to improve the meter's performance when installation and application conditions are not ideal. Typical interferences from process conditions such as pump pulsations, mechanical vibrations, oscillating valves can be reduced considerably.

**Integration**

The SITRANS FCS400 Massflow sensor is suitable for both indoor and outdoor installation and meets the requirements of Protection Class IP67/NEMA 4X. Optionally the sensor can be supplied with hazardous certification to Class 1 Zone 1 (ATEX, IECEx) or Class 1 Div. 1 (FM).

The flowmeter is bidirectional and can be installed in any orientation. The sensor is self-draining in many positions, with vertical mounting preferred.

It is important to ensure that the sensor tubes are always completely filled with homogeneous fluid; otherwise measuring errors may occur. Suitable fluids are clean liquids, pastes, light slurries or gases. Condensing vapours, aerated liquids or slush are not recommended.

The materials in contact with the process medium must be evaluated for corrosion and erosion resistances for long sensor life.

The pressure drop through the sensor is a function of the properties of the fluid and the flow rate. A pressure loss and accuracy calculator can be found on the Siemens Internet site [www.siemens.com/fc430/sizer](http://www.siemens.com/fc430/sizer)

The preferred flow direction is indicated by an arrow on the sensor. Flow in the direction of the arrow will be measured as positive. The flow direction can be adjusted at the transmitter to compensate for reverse installation.

**Installation orientation**

The optimal installation orientation is vertical with the flow upwards. This ensures that suspended solids or bubbles are completely pushed through the sensor. A drain valve below the sensor will allow the pipe and sensor to drain completely.

**Supports**

In order to support the weight of the flowmeter and to ensure reliable measurements when external effects exist (e.g. plant vibrations), the sensor should be installed in rigidly supported pipelines.

Supports or hangers should be installed symmetrically and stress-free in close proximity to both of the process connections.

**Shut-off devices**

To conduct a system zero adjustment, secure shut-off devices are required in the pipeline.

Where possible, shut-off devices should be installed both upstream and downstream of the flowmeter.

**System design**

- The sensor design consists of process connections, inlet and outlet manifolds mounted in a stiff frame and two parallel tubes equally sharing the process medium flow. The meter is protected in a pressure-rated stainless steel enclosure with two purge ports to support a pressure guard in non-Ex applications.
- The sensing tubes are curved in the CompactCurve shape which gives high sensitivity and low pressure loss. The CompactCurve shape was selected to ensure that the smallest flows are measured with optimal signal to noise ratio.
- Vibration mode separation creates a controlled measuring environment only within the CompactCurve part of the tubes. As a result the sensor has high immunity to plant vibration while avoiding large mass balancing of the meter components.
- The 15° slope of the CompactCurve shape ensures secure self-draining when the sensor axis is mounted vertically or up to 10° off vertical.
- The sensor frame is designed to conduct plant vibrations directly through the sensor body to adjacent pipeline while providing isolation of the metering section from the vibration. Careful mounting of the pipeline with regard to minimizing vibration at the meter will ensure a secure measurement environment.

**Installation guidelines**

- The mass flowmeter does not require any flow conditioning or straight inlet pipe sections. Care should be exercised however to ensure that any upstream valves, gates, sight glasses etc. do not cavitate and are not set into vibration by the flow.
- It is always preferred to place the flowmeter upstream of any control valve (what goes in, comes out) or other pipeline component which may cause flashing, cavitation or vibrations.
- The presence of gas bubbles in the fluid may result in erroneous measurements, particularly in the density measurement. Therefore the flowmeter should not be installed at the lowest pressure point in the liquid piping system or where vapour can collect. Install the meter in pipeline sections with high pressure to maintain system pressure and compress any bubbles.
- Drop lines downstream from the flow sensor should be avoided to prevent the meter tube from draining during flowing conditions. A back-pressure device or orifice is recommended to ensure that flow does not separate within the flow sensor but the metering section remains at positive pressure at all times while there is flow.

## Flow Measurement

### SITRANS F C

#### Flow sensor SITRANS FCS400

- The flowmeter should not come into contact with any other objects. Avoid making attachments to the housing except for the pressure guard components (if required).
- When the connecting pipeline is larger than the sensor size, suitable standard reducers may be installed. A selection of oversize and undersize connections can be ordered - refer to the sizes tables below.
- The flow sensor may be supported at the junction between process connection and the manifold, but should not be used to support adjacent piping. Ensure that the piping is also supported on both sides so that connection stresses are neutral.
- If strong vibrations exist in the pipeline, they should be damped using elastic pipeline elements. The damping devices must be installed outside the supported flowmeter section. Direct connection of flexible elements to the sensor should be avoided.
- Make sure that any dissolved gases, which are present in many liquids, do not outgas. The back pressure at the outlet should be at least 0.2 bar (3 psi) above the vapour pressure of the process fluid.
- Assure that operation below the vapour pressure cannot occur particularly for fluids with low latent heat of vaporisation.
- The sensor should not be installed in the vicinity of strong electromagnetic fields, e.g. near motors, pumps, variable frequency drives, transformers etc.
- When operating meters on a common mounting base the sensors should be mounted and spaced separate from each other to avoid cross-talk and other vibration interferences.
- When operating meters in interconnected pipelines the pipes should be decoupled to prevent cross talk.

#### Remote system cabling

The system is designed so that standard instrumentation cable with four cores and overall screen or two screened pairs can be used, or cable sets can be ordered with the flowmeter. The cable can be ordered in various set lengths and terminated in the field.

The maximum design length for the sensor cable is 200 m (656 ft), limited to 150 m (492 ft) for Ex applications with Class IIC gases. Data transmission speed and process variable update rates may be affected by the cable characteristics. For best results, choose a cable with the following electrical characteristics:

Property	Unit	Value
Resistance	[ $\Omega$ /km]	59
Characteristic impedance	[ $\Omega$ ]	100 @ 1 MHz
Insulation resistance	[M $\Omega$ /km]	200
Maximum voltage	[V]	300

The flowmeter system applies maximum 15 V DC in operation and is certified intrinsically safe. The complete system is insulation tested to 1500 V in production.

Cabling solutions which can be ordered with the flowmeter are as follows:

1. High performance plugged cable using M12 plugs into prepared sockets
2. Cable glands for either metric or NPT threaded terminal housings.
3. Plain cable in set lengths to be passed through flexible and rigid conduit (not supplied) for metric or NPT threaded terminal housings

Cable for items 1, 2 and 3 are available either gray for standard applications or light blue for Ex applications to identify the circuit as intrinsically safe.

#### Insulation and heating

For applications where pipeline insulation is required for personnel protection or process temperature maintenance, the SITRANS FCS400 flow sensor may also be insulated. The form and material of insulation is not prescribed and entirely depends on the practices at the application location or plant.

Insulation must not be crowded around the sensor pedestal but shaped at a 45° cone to allow the pedestal to radiate excess heat and maintain a suitable working temperature within the front-end housing.

Where trace heating is employed, an electric heating jacket can be ordered as an accessory. It is shaped to the sensor body and controlled from a weatherproof setpoint device.

The jacket can heat the sensor enclosure up to 200 °C (392 °F). However further insulation is also recommended for personnel protection or low loss temperature maintenance.

#### Calibration

To ensure accurate measurement all flowmeters must be initially calibrated. The calibration of each SITRANS FCS400 coriolis sensor is conducted at SIEMENS flow facilities accredited according to ISO/IEC 17025 by DANAK. A calibration certificate is shipped with every sensor and calibration data are stored in the SensorFlash memory unit. The accreditation body DANAK has signed the ILAC MRA agreement (International Laboratory Accreditation Corporation - Mutual Recognition Arrangement). Therefore the accreditation ensures international traceability and recognition of the test results in 39 countries worldwide, including the US (NIST traceability).

## Technical specifications

Flow sensor FCS400		
Parameter	Unit	Value
Process pressure range	[barg (psi)]	316L: 0 ... 100 (0 ... 1450) Hastelloy C22: 0 ... 160 (0 ... 2321)
Process temperature range	[°C (°F)]	-50 ... +200 (-58 ... +392)
Ambient temperature range	[°C (°F)]	-40 ... +60 (-40 ... +140)
Transport temperature range	[°C (°F)]	-40 ... +70 (-40 ... +158)
Density range	[kg/m <sup>3</sup> (lb/ft <sup>3</sup> )]	1 ... 5000 (0.062 ... 312.2)
Process media	Fluid group	1 (suitable for dangerous fluids)
	Form	Light slurry, liquid and non-condensing gas
No. of process values		
• Primary process values		<ul style="list-style-type: none"> <li>• Mass flow</li> <li>• Density</li> <li>• Process medium temperature</li> </ul>
• Derived process values		<ul style="list-style-type: none"> <li>• Volume flow</li> <li>• Corrected volume flow (with reference density)</li> <li>• Fraction A:B</li> <li>• Fraction % A:B</li> </ul>

Performance specifications		Sensor			
Parameter	Unit	DN 15	DN 25	DN 50	DN 80
Max. zero point error	[kg/h (lb/min)]	0.2 (0.007)	2.0 (0.072)	7.5 (0.276)	18 (0.66)
Qmin	[kg/h (lb/min)]	20 (0.735)	200 (7.35)	750 (27.6)	900 (33.1)
Qnom	[kg/h (lb/min)]	3 700 (136.0)	11 500 (422.6)	52 000 (1 911)	136 000 (4 997)
Qmax	[kg/h (lb/min)]	6 400 (14 110)	17 700 (39 022)	70 700 (155 867)	181 000 (399 036)
Linearity error	[%]	± 0.1	± 0.1	± 0.1	± 0.1
Repeatability	[%]	± 0.05	± 0.05	± 0.05	± 0.05
Density error	[kg/m <sup>3</sup> (lb/ft <sup>3</sup> )]	± 5 (± 0.31)	± 5 (± 0.31)	± 5 (± 0.31)	± 5 (± 0.31)
Extended density calibration	[kg/m <sup>3</sup> (lb/ft <sup>3</sup> )]	± 1 (± 0.062)	± 1 (± 0.062)	± 1 (± 0.062)	± 1 (± 0.062)
Temperature error	[°C (°F)]	± 0.5 (± 0.9)	± 0.5 (± 0.9)	± 0.5 (± 0.9)	± 0.5 (± 0.9)

## Pressure/temperature curves

With two major exceptions, the pressure rating of the flow sensors is independent of the process medium temperature. Design rules for flange connections in both the EN1092-1 and ASME B16.5 standards dictate pressure derating with increasing temperature. The charts below show the effect of process medium temperature on the pressure ratings for the flanges within the FCS400 product program.

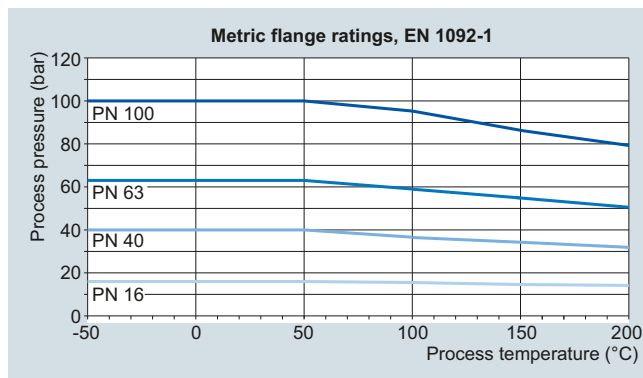

EN1092-1 flanged sensors

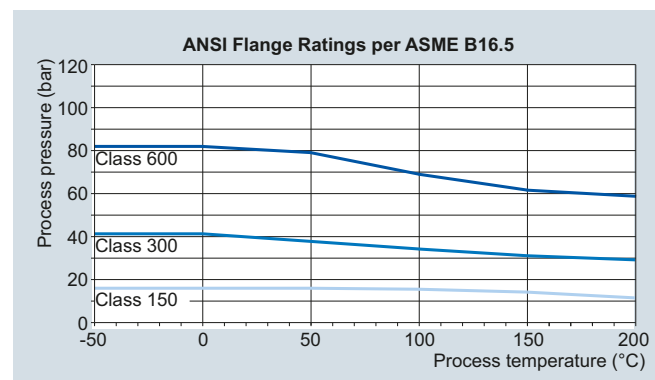

ASME B16.5 flanged sensors

## Flow Measurement

### SITRANS F C

#### Flow sensor SITRANS FCS400

##### Sensor variants

SITRANS FCS400 sensors are available in three main variants: Standard, hygienic and NAMUR. A wide range of process connections is available for the FCS400 sensors. The available combinations of type, sensor size and connection size are shown in the tables below.

##### Standard sensors

Sensor	Connection	EN 1092-1 B1, PN 16	EN 1092-1 B1, PN 40	EN 1092-1 B1, PN 63	EN 1092-1 B1, PN 100	EN 1092-1 D Nut, PN 40	EN 1092-1 D Nut, PN 63	EN 1092-1 D Nut, PN 100	ANSI B16.5-2009, class 150	ANSI B16.5-2009, class 300	ANSI B16.5-2009, class 600	ISO 228-1 G pipe thread	ASME B1.20.1 NPT pipe thread	DIN 11851 Hygienic screwed	DIN 32676 Hygienic Tri-clamp	DIN 11864-1A Aseptic screwed	DIN 11864-2A Aseptic flanged	ISO 2852 Hygienic clamped	ISO 2853 Hygienic screwed	SMS 1145 Hygienic screwed	12-VCO-4 Quick connect	JIS B2200:2004/10K	JIS B2200:2004/20K	JIS B2200:2004/40K
<b>316 Stainless - Standard: 7ME461.-...</b>																								
DN 15 (½")	DN 6 (¼")										o	o												
	DN 10 (¾")												o											
	DN 15 (½")	●	●	o	●	o	o	o	●	●	●	●	●	●	●	●	●				o	o	o	o
	DN 20 (¾")		●						●	o	●				●									
	DN 25 (1")	●	●		●									o					●	●	o			
DN 25 (1")	DN 15 (½")																							
	DN 25 (1")	●	●	o	●	o	o	o	●	o	●	●	●	●	●	●	●	●	●	o		o	o	o
	DN 32 (1¼")		●											o										
DN 40 (1½")	o	●		o				o	o	o				●			o	o						
DN 50 (2")	DN 25 (1")																							
	DN 40 (1½")	o	●	o	●	o	o	o						o		●	●	o	o	o				
	DN 50 (2")	●	●	o	●	o	o	o	●	●	●	●	●	●	●	●	●	●	●	o		o	o	o
	DN 65 (2½")																							
DN 80 (3")	DN 50 (2")																							
	DN 65 (2½")	o	●	o	o				●	o	●			●										
	DN 80 (3")	●	●	o	●	o	o	o	●	●	●			●	●	●	●	●	●	o		o	o	o
	DN 100 (4")	●	o	o	o																			

- Combinations shown ● are Mainstream products with delivery time of up to 15 days depending on the combination and production stock levels.
- Combinations shown o are Sidestream products with delivery from 45 to 90 days. Not all components are held in production stock for Sidestream products.

### Hygienic sensor variants

The hygienic sensors all have maximum internal surface roughness < 0.8 µm and are EHEDG and 3A approved. Hygienic sensors are offered with process connection conforming to various international quick-connect clamps or threaded connectors. Pressure ratings are according to the relevant standard and the sensor size. Maximum pressure in the hygienic program is PN 40.

Sensor	Connection	316 SS - Hygienic: 7ME462-...					
		DIN 11851 0.8 µm screwed	DIN 32676 0.8 µm Tri-clamp	DIN 11864-1 0.8 µm screwed	DIN 11864-2 0.8 µm flanged	ISO 2852 0.8 µm clamped	ISO 2853 0.8 µm screwed
DN 15 (1/2")	DN 6 (1/4")						
	DN 10 (3/8")	○					
	DN 15 (1/2")	●	●	●	●		
	DN 20 (3/4")		●				
	DN 25 (1")	○				●	●
DN 25 (1")	DN 15 (1/2")						
	DN 25 (1")	●	●	●	●	●	●
	DN 32 (1 1/4")	○					
	DN 40 (1 1/2")		●			○	○
DN 50 (2")	DN 25 (1")						
	DN 40 (1 1/2")	○		○	●	○	○
	DN 50 (2")	●	●	●	●	●	●
	DN 65 (2 1/2")						
DN 80 (3")	DN 50 (2")						
	DN 65 (2 1/2")	●					
	DN 80 (3")	●	●	●	●	●	●
	DN 100 (4")						

- Combinations shown ● are Mainstream products with delivery time of up to 15 days depending on the combination and production stock levels.
- Combinations shown ○ are Sidestream products with delivery from 45 to 90 days. Not all components are held in production stock for Sidestream products.

### Aseptic flanged process connections

The aseptic flanges offered for FCS400 conform with the standard DIN 11864-2A BF-A. The flange fitted to the sensor is therefore the back flange and the seal is an O-ring.

The flange dimensions in the FCS400 program are as follows:

Size DN	Pipe	Bore d <sub>1</sub>	Ring OD d <sub>11</sub>	Bolt Circle d <sub>5</sub>	Bolt holes	Flange diameter d <sub>10</sub>
10	13 x 1.5	10	22.4	37	4 x Ø9	54
15	19 x 1.5	16	28.4	42	4 x Ø9	59
20	23 x 1.5	20	32.4	47	4 x Ø9	64
25	29 x 1.5	26	38.4	53	4 x Ø9	70
32	35 x 1.5	32	47.7	59	4 x Ø9	76
40	41 x 1.5	38	53.7	65	4 x Ø9	82
50	53 x 1.5	50	65.7	77	4 x Ø9	94
65	70 x 2.0	66	81.7	95	8 x Ø9	107
80	85 x 2.0	81	97.7	112	8 x Ø11	113

DIN 11864-2A BF-A flange dimensions

## Flow Measurement

### SITRANS F C

#### Flow sensor SITRANS FCS400

##### NAMUR sensor variants

The NAMUR variants have build-in lengths according to NAMUR recommendation NE 132. The recommendations of NE 132 are stated for sensors with flanges the same size as the sensor nominal size, and for flanges to EN1092-1 PN 40 with B1 flange facing. For couplings of other standards such as ASME B16.5 Class 150, the overall length incorporates the difference in length between standard EN and ASME flanges. NAMUR variants are offered with flange and pipe thread connections according to EN, ISO and ASME standards, as shown in the table below.

Sensor	Connection	EN 1092-1 B1, PN 16	EN 1092-1 B1, PN 40	EN 1092-1 B1, PN 63	EN 1092-1 B1, PN 100	EN 1092-1 D Nut, PN 40	EN 1092-1 D Nut, PN 63	EN 1092-1 D Nut, PN 100	ANSI B16.5-2009, class 150	ANSI B16.5-2009, class 300	ANSI B16.5-2009, class 600	ISO 228-1 G pipe thread	ASME B1.20.1 NPT pipe thread	DIN 11851 Hygienic screwed	DIN 32676 Hygienic Tri-clamp	DIN 11864-1 A Aseptic screwed	DIN 11864-2 A Aseptic flanged	ISO 2852 Hygienic clamped	ISO 2853 Hygienic screwed
<b>316 Stainless - NAMUR: 7ME471-...</b>																			
DN 15 (½")	DN 6 (¼")											○	○						
	DN 10 (⅜")													○					
	DN 15 (½")	○	●	○	●	○	○	○	●	○	●	●	●	●	●	●	●		
	DN 20 (¾")								●	○	●				●				
	DN 25 (1")	○	●		●										○				●
DN 25 (1")	DN 15 (½")																		
	DN 25 (1")	○	●	○	●	○	○	○	●	○	●	●	●	●	●	●	●	●	●
	DN 32 (1¼")													○					
	DN 40 (1½")	○	●		○				○	○	○				●			○	○
DN 50 (2")	DN 25 (1")																		
	DN 40 (1½")	○	●	○	●	○	○	○						○		○	●	○	○
	DN 50 (2")	○	●	○	●	○	○	○	●	○	●	●	●	●	●	●	●	●	●
	DN 65 (2½")	○																	
DN 80 (3")	DN 50 (2")																		
	DN 65 (2½")	○	●	○	○				●	○	●			●					
	DN 80 (3")	○	●	○	●	○	○	○	●	○	●			●	●	●	●	●	●
	DN 100 (4")	○	○	○	○														

- Combinations shown ● are Mainstream products with delivery time of up to 15 days depending on the combination and production stock levels.
- Combinations shown ○ are Sidestream products with delivery from 45 to 90 days. Not all components are held in production stock for Sidestream products.

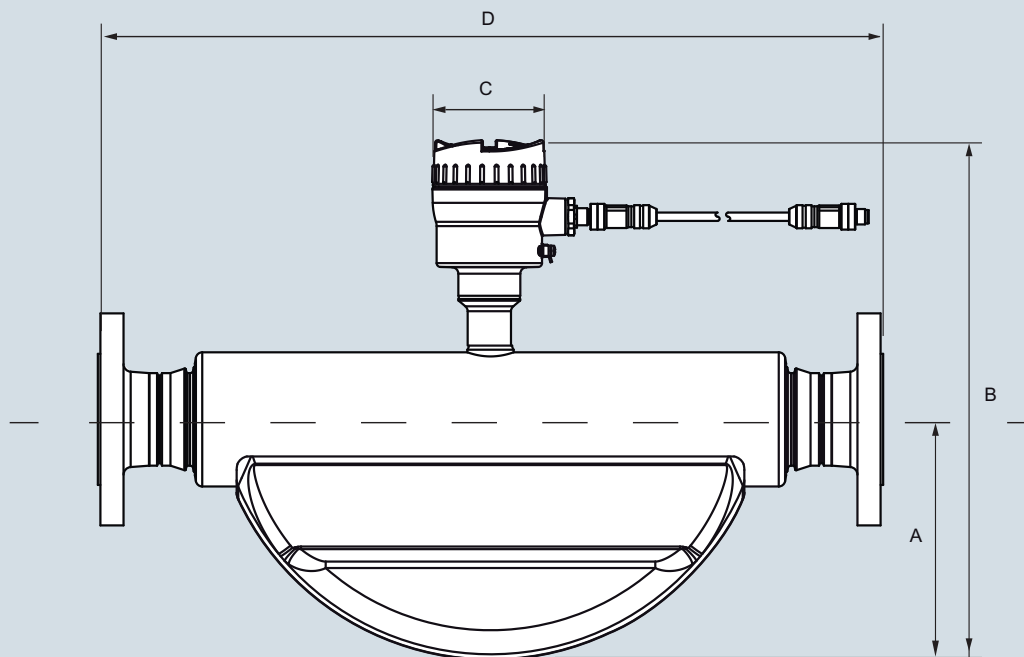
**Dimensional drawings**

Sensor [DN]	[inch]	A		B		C		Weight	
		[mm]	[inch]	[mm]	[inch]	[mm]	[inch]	[kg]	[lb]
15	½	90	3.54	280	11.0	90	3.54	4.6	10.1
25	1	123	4.84	315	12.4	90	3.54	7.9	17.4
50	2	187	7.36	390	15.4	90	3.54	25.7	56.7
80	3	294	11.6	504	19.8	90	3.54	66.5	147

SITRANS FCS400, dimensions in mm (inch), weights in kg (lb), for a EN 1092 PN 40 flanged version.

The build-in length D depends on the flange.

## Flow Measurement

### SITRANS F C

#### Flow sensor SITRANS FCS400

##### Overall length

The overall length (build-in length) of each sensor depends on the connection standard and the pressure rating. The tables below summarize the dimensions available at the time of publishing. Please contact Siemens for further information about our desired process connection specification.

316L stainless - Standard: 7ME461.-...

Sensor	DN 15 (½")					DN 25 (1")			DN 50 (2")		DN 80 (3")		
	DN 6 (¼")	DN 10 (3/8")	DN 15 (½")	DN 20 (¾")	DN 25 (1")	DN 25 (1")	DN 32 (1¼")	DN 40 (1½")	DN 40 (1½")	DN 50 (2")	DN 65 (2½")	DN 80 (3")	DN 100 (4")
EN 1092-1 B1, PN 16			265		265	360			610	610	915	840	840
EN 1092-1 B1, PN 40			265		265	360		365	610	610	915	840	840
EN 1092-1 B1, PN 63			265			360			610	610	915	915	915
EN 1092-1 B1, PN 100			270		275	360			610	610	915	915	915
ANSI B16.5, class 150			270	270		360		365		620	915	875	
ANSI B16.5, class 300			270	270		360		380		620	915	875	
ANSI B16.5, class 600			270	285		360		380		620	915	875	
ISO 228-1 GH pipe thread	265		265			365				620			
ANSI B1.20.1 NPT pipe thread	265		270			365				620			
DIN 11851 Hygienic screwed		265	265		193	360	360		610	610	840	840	
DIN 32676-C Hygienic clamp			265	265		360		360		610		875	
DIN 11864-1 Aseptic screwed			265	265		360				610		875	
DIN 11864-2 Aseptic flange			265	265		360		274	620	610		875	
ISO 2852 Hygienic clamp					265	360			610	610		840	
ISO 2853 Hygienic screwed			265			360		274		610		860	

SITRANS FCS400, overall length, dimensions in mm

Sensor	DN 15 (½")					DN 25 (1")			DN 50 (2")		DN 80 (3")		
	DN 6 (¼")	DN 10 (3/8")	DN 15 (½")	DN 20 (¾")	DN 25 (1")	DN 25 (1")	DN 32 (1¼")	DN 40 (1½")	DN 40 (1½")	DN 50 (2")	DN 65 (2½")	DN 80 (3")	DN 100 (4")
EN 1092-1 B1, PN 16			10.43		10.43	14.17			24.02	24.02	36.02	33.07	33.07
EN 1092-1 B1, PN 40			10.43		10.43	14.17		14.37	24.02	24.02	36.02	33.07	33.07
EN 1092-1 B1, PN 63			10.43			14.17			24.02	24.02	36.02	36.02	36.02
EN 1092-1 B1, PN 100			10.63		10.83	14.17			24.02	24.02	36.02	36.02	36.02
ANSI B16.5, class 150			10.63	10.63		14.17		14.37		24.41	36.02	34.45	
ANSI B16.5, class 300			10.63	10.63		14.17		14.96		24.41	36.02	34.45	
ANSI B16.5, class 600			10.63	11.22		14.17		14.96		24.41	36.02	34.45	
ISO 228-1 GH pipe thread	10.43		10.43			14.37				24.41			
ANSI B1.20.1 NPT pipe thread	10.43		10.63			14.37				24.41			
DIN 11851 Hygienic screwed		10.43	10.43		7.60	14.17	14.17		24.02	24.02	33.07	33.07	
DIN 32676-C Hygienic clamp			10.43	10.43		14.17		14.17		24.02		34.45	
DIN 11864-1 Aseptic screwed			10.43	10.43		14.17				24.02		34.45	
DIN 11864-2 Aseptic flange			10.43	10.43		14.17		10.78	24.41	24.02		34.45	
ISO 2852 Hygienic clamp					10.43	14.17			24.02	24.02		33.07	
ISO 2853 Hygienic screwed			10.43			14.17		10.78		24.02		33.86	

SITRANS FCS400, overall length, dimensions in inch



316L stainless - Hygienic 0.8 µm: 7ME462-...

Sensor	DN 15 (½")				DN 25 (1")			DN 50 (2")		DN 80 (3")	
	DN 10 (3/8")	DN 15 (½")	DN 20 (¾")	DN 25 (1")	DN 25 (1")	DN 32 (1¼")	DN 40 (1½")	DN 40 (1½")	DN 50 (2")	DN 65 (2½")	DN 80 (3")
DIN 11851 Hygienic screwed	265	265			360	360		610	610	840	840
DIN 32676-C Hygienic clamp		265	265		360		360		610		875
DIN 11864-1 Aseptic screwed		265			360				610		875
DIN 11864-2 Aseptic flange		265			360			620	610		875
ISO 2852 Hygienic clamp				265	360			610	610		840
ISO 2853 Hygienic screwed				265	360				610		860

SITRANS FCS400, overall length, dimensions in mm

Sensor	DN 15 (½")				DN 25 (1")			DN 50 (2")		DN 80 (3")	
	DN 10 (3/8")	DN 15 (½")	DN 20 (¾")	DN 25 (1")	DN 25 (1")	DN 32 (1¼")	DN 40 (1½")	DN 40 (1½")	DN 50 (2")	DN 65 (2½")	DN 80 (3")
DIN 11851 Hygienic screwed	10.43	10.43		7.60	14.17	14.17		24.20	24.20	33.07	33.07
DIN 32676-C Hygienic clamp		10.43	10.43		14.17		14.17		24.20		34.45
DIN 11864-1 Aseptic screwed		10.43			14.17				24.20		34.45
DIN 11864-2 Aseptic flange		10.43			14.17			24.41	24.20		34.45
ISO 2852 Hygienic clamp				10.43	14.17			24.20	24.20		33.07
ISO 2853 Hygienic screwed				10.43	14.17				24.20		33.86

SITRANS FCS400, overall length, dimensions in inch

## Flow Measurement

### SITRANS F C

#### Flow sensor SITRANS FCS400

316L stainless - NAMUR: 7ME471.-...









Sensor	DN 15 (½")					DN 25 (1")			DN 50 (2")		DN 80 (3")		
	DN 6 (¼")	DN 10 (3/8")	DN 15 (½")	DN 20 (¾")	DN 25 (1")	DN 25 (1")	DN 32 (1¼")	DN 40 (1½")	DN 40 (1½")	DN 50 (2")	DN 65 (2½")	DN 80 (3")	DN 100 (4")
EN 1092-1 B1, PN 16			510		510	600			715	715	915	915	915
EN 1092-1 B1, PN 40			510		510	600			715	715	915	915	915
EN 1092-1 B1, PN 63			510			600			715	715	915	915	915
EN 1092-1 B1, PN 100						600			715	715	915	915	915
EN 1092-1 D, PN 16			510			600			715	715		915	
EN 1092-1 D, PN 40			510			600			715	715		915	
EN 1092-1 D, PN 63						600			715	715		915	
ANSI B16.5, class 150						600					915		
ANSI B16.5, class 300						600					915		
ANSI B16.5, class 600						600					915		
ISO 228-1 GH pipe thread	510		510										
ANSI B1.20.1 NPT pipe thread	510												
DIN 11851 Hygienic screwed		510	510			600	600		715	715	915	915	
DIN 32676-C Hygienic clamp			510	510		600	600		715				
DIN 11864-1 Aseptic screwed			510			600			715				
DIN 11864-2 Aseptic flange													
ISO 2852 Hygienic clamp					510	600			715	715		915	
ISO 2853 Hygienic screwed					510	600			715				

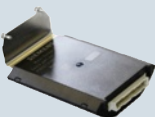
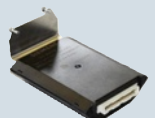



SITRANS FCS400, overall length, dimensions in mm

Sensor	DN 15 (½")					DN 25 (1")			DN 50 (2")		DN 80 (3")		
	DN 6 (¼")	DN 10 (3/8")	DN 15 (½")	DN 20 (¾")	DN 25 (1")	DN 25 (1")	DN 32 (1¼")	DN 40 (1½")	DN 40 (1½")	DN 50 (2")	DN 65 (2½")	DN 80 (3")	DN 100 (4")
EN 1091-1 B1, PN 16			20.08		20.08	23.62			28.15	28.15	36.02	36.02	36.02
EN 1091-1 B1, PN 40			20.08		20.08	23.62			28.15	28.15	36.02	36.02	36.02
EN 1091-1 B1, PN 63			20.08			23.62			28.15	28.15	36.02	36.02	36.02
EN 1091-1 B1, PN 100						23.62			28.15	28.15	36.02	36.02	36.02
EN 1092-1 D, PN 16			20.08			23.62			28.15	28.15		36.02	
EN 1092-1 D, PN 40			20.08			23.62			28.15	28.15		36.02	
EN 1092-1 D, PN 63						23.62			28.15	28.15		36.02	
ANSI B16.5, class 150						23.62					36.02		
ANSI B16.5, class 300						23.62					36.02		
ANSI B16.5, class 600						23.62					36.02		
ISO 228-1 GH pipe thread	20.08		20.08										
ANSI B1.20.1 NPT pipe thread	20.08												
DIN 11851 Hygienic screwed		20.08	20.08			23.62	23.62		28.15	28.15	36.02	36.02	
DIN 32676-C Hygienic clamp			20.08	20.08		23.62	23.62		28.15				
DIN 11864-1 Aseptic screwed			20.08			23.62			28.15				
DIN 11864-2 Aseptic flange													
ISO 2852 Hygienic clamp					20.08	23.62			28.15	28.15		36.02	
ISO 2853 Hygienic screwed					20.08	23.62			28.15				



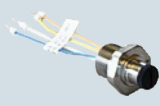

SITRANS FCS400, overall length, dimensions in inch

**Spare parts - transmitter FCT030**

Description	Article No.	
Display and keypad assembly with firewire connection to the transmitter module <sup>1)</sup>	<b>A5E03548971</b>	
Sensor interface (Compact). Front end flow calculator and process detection. SIL 3 approved <sup>1)</sup>	<b>A5E03549142</b>	
Sensor interface (Remote); barrier unit for high speed digital communication and Ex ib power supply to remote front end DSL module	<b>A5E03549098</b>	
Display lid in painted aluminum with Ex glass plate and o-ring seal	<b>A5E03549344</b>	
Transmitter cassette (active) with SIL approved 4 ... 20 mA output and HART 7.2 <sup>1)</sup>	<b>A5E03549357</b>	
Transmitter cassette (passive) with SIL approved 4 ... 20 mA output and HART 7.2 <sup>1)</sup>	<b>A5E03549383</b>	
Bag of loose spare parts; including cable strain relief components, mounting tool, seals and gasket, assorted screws and washers, hex cap nut, blind plugs, and o-rings	<b>A5E03549396</b>	
Power supply 240 V AC, 47 ... 63 Hz 24 ... 90 V DC	<b>A5E03549413</b>	
Blind lid in painted aluminum with o-ring seal	<b>A5E03549429</b>	
I/O assembly Advise Order code F00 to F97 from Selection and Ordering data <sup>2)</sup>	<b>A5E03939114</b>	
SensorFlash (micro SD card)	<b>A5E03915258</b>	

Description	Article No.	
Mounting bracket - FCT030; in painted aluminum for pipe or wall mounting of transmitter FCT030 remote version. Including lock ring, pressure pads and seal cap	<b>A5E03906091</b>	
M12 option for sensor housing in stainless steel. Pre-wired and potted to replace M12 socket in DSL housing	<b>A5E03906095</b>	
M12 option - remote - in painted aluminum. Pre-wired and potted to replace M12 connection for FCT030 transmitter remote version	<b>A5E03906104</b>	
Remote terminal house - M20	<b>A5E03906112</b>	
Remote terminal house - NPT - in painted aluminum for sensor cable termination at FCT030 transmitter remote version. Pre-wired and potted	<b>A5E03906130</b>	

**Spare parts - sensor FCS400**

Description	Article No.	
Blind lid in painted aluminum with o-ring seal	<b>A5E03549295</b>	
Sensor link insert. Front end flow calculator and process detection. SIL 3 approved <sup>1)</sup>	<b>A5E03549191</b>	
Sensor housing metric	<b>A5E03549313</b>	
Sensor housing NPT in painted aluminum	<b>A5E03906080</b>	
Bag of loose parts for sensor; including cable strain relief components, washer, seals, o-rings, and assorted screws	<b>A5E03549324</b>	

<sup>1)</sup> The system firmware bundle must be stated in the "Remark" field to ensure compatibility of the system. The FW revision is found on the product label and in the local display menu items 3.1.10. e.g. "2.02.01-02"

<sup>2)</sup> The I/O configuration must be stated in the "Remark" field. The I/O configuration is found in the F option of the ordering code. e.g. code "F40" for ordering Ch2 Active Current/Freq/Pulse, Ch3 Active Current/Freq/Pulse, Ch4 Active Input

# FINE CONTROLS (UK) LTD



Fine Controls have been supplying process controls & instrumentation equipment since 1994, & now serves an ever expanding customer base, both in the UK & globally.

We offer a full range of valve & instrumentation products & services, with our product range representing leading technologies & brands:

**Flow:** Flow Meters & Transmitters, Flow Switches, Flow Control Valves & Batch Control Systems

**Temperature:** Temperature Probes & Thermowells, Temperature transmitters, Temperature Regulators & Temperature Displays

**Level:** Level Transmitters & Switches

**Pressure:** Pressure Gauges & Transmitters, Precision & High Pressure Regulators & I-P Converters, Volume boosters.

**Precision Pneumatics:** Pressure Regulators, I-P Converters, Volume Boosters, Vacuum Regulators

**Valves:** Solenoid & Pneumatic Valves, Control Valves & Positioners, Actuated Ball, Globe or Diaphragm Valves & Isolation Valves

**Services:** Repair, Calibration, Panel Build, System Design & Commissioning

A rotork® Brand  
**FAIRCHILD**



**bürkert**



**SIEMENS**



**alcon**  
SOLENOID VALVES

A rotork® Brand



**MIDLAND-ACS**  
A rotork® Brand



**Honeywell**



**Bourdon**  
Baumer Group



**SOLDO**  
CONTROLS

A rotork® Brand



Fine Controls (UK) LTD, Bassendale Road, Croft Business Park,  
Bromborough, Wirral, CH62 3QL UK  
Tel: 0151 343 9966  
Email: sales@finecontrols.com