

## Overview



SITRANS F C coriolis mass flowmeters are designed for measurement of a variety of liquids and gases. The meter is a multi-parameter device offering accurate measurement of mass flow, volume flow, density, temperature and fraction.

Transmitter	Page	Compact	Remote	Ex-Approval	Sensor	Page
MASS 6000 IP67 Polyamide enclosure	4/130	No	Yes	No	FC300 DN 4	4/154
		No	Yes	No	MASS 2100 DI 1.5	4/150
		Yes	Yes	No	MASS 2100 DI 3 ... DI 40	4/159
		No	Yes	No	MASS MC2 DN 50...DN150	4/169
		No	Yes	Yes	MASS MC2-Ex DN 50...DN150	4/169
		No	Yes	No	MASS MC2 Hygienic DN 20 ... DN 80	4/169
MASS 6000 19"	4/134	No	Yes	No	FC300 DN 4	4/154
		No	Yes	No	MASS 2100 DI 1.5	4/150
		No	Yes	No	MASS 2100 DI 3 ... 40	4/159
		No	Yes	No	MASS MC2 DN 50...DN150	4/169
		No	Yes	Yes	MASS MC2-Ex DN 50...DN150	4/169
		No	Yes	No	MASS MC2 Hygienic DN 20 ... DN 80	4/169
MASS 6000 Ex 19"	4/134	No	Yes	Yes	FC300 DN 4	4/154
		No	Yes	Yes	MASS 2100-Ex DI 1.5	4/150
		No	Yes	Yes	MASS 2100-Ex DI 3 ... DI 40	4/159
MASS 6000 Ex d Stainless steel enclosure	4/141	No	Yes	Yes	FC300 DN 4	4/154
		No	Yes	Yes	MASS 2100-Ex DI 1.5	4/150
		Yes	Yes	Yes	MASS 2100-Ex DI 3 ... DI 40	4/159
		No	Yes	No	MASS MC2 DN 50...DN150	4/169
		No	Yes	No	MASS MC2 Hygienic DN 20 ... 80	4/169
SIFLOW FC070 Standard/Ex	4/146	No	Yes	Yes	all	4/150

## Benefits

### Greater flexibility

- Wide product program
- Uniform sensor interface enabling "plug & play" for all transmitters
- Compact or remote installation using the same transmitters and sensors

### Easier commissioning

All SITRANS F C coriolis flowmeters feature a SENSORPROM memory unit which stores sensor calibration data and transmitter settings for the lifetime of the product.

At commissioning the flowmeter commences measurement without any initial programming.

The factory settings matching the sensor size are stored in the SENSORPROM unit. Also customer-specified settings are downloaded to the unit.

### Easier service

- Comprehensive self-diagnosis and service menu enhances troubleshooting and meter verification.
- Transmitter replacement requires no programming. SENSORPROM automatically updates all settings after initialization.

### Room for growth

USM II the Universal Signal Module with "plug & play" simplicity makes it easy to access and integrate the flowmeter with almost any system and bus-protocol and it ensures the flowmeter will be easy to upgrade to future communication/bus platforms.

## Application

Coriolis mass flowmeters are suitable for measuring liquids and gases. The measurement is independent of changes in process conditions/parameters such as temperature, density, pressure, viscosity, conductivity and flow profile.

Due to this versatility the meter is easy to install. The coriolis flowmeter is recognized for its high accuracy in a wide turn-down range.

### The main applications of the coriolis flowmeter can be found in all industries, such as:

<b>Chemical &amp; pharma</b>	Detergents, bulk chemicals, pharmaceuticals, acids, alkalis
<b>Food &amp; beverage</b>	Dairy products, beer, wine, soft-drinks, plato/brix, fruit juices and pulps, bottling, CO <sub>2</sub> dosing, CIP-liquids
<b>Automotive</b>	Fuel injection nozzle & pump testing, filling of AC units, engine consumption, paint robots
<b>Oil &amp; gas</b>	Filling of gas bottles, furnace control, CNG-dispensers, Test separators, LPG
<b>Water &amp; waste water</b>	Dosing of chemicals for water treatment

# SITRANS F flowmeters

## SITRANS F C

### System information SITRANS F C Coriolis mass flowmeters

Please see Product selector  
[www.pia-selector.automation.siemens.com](http://www.pia-selector.automation.siemens.com)  
on the Internet, since  
some constraints might be related to  
some of the features



	MASS 2100 DI 1.5	MASS 2100 DI 3 to DI 40	FC300 DN 4	MC2 DN 50 to DN 150	MC2 Hygienic DN 25 to DN 80	MASS 6000 IP67	MASS 6000 19"	MASS 6000 Ex d	SIFLOW FC070 Std/Ex
	7ME4100	7ME4100, 7ME4200, 7ME4210	7ME4400	7ME4300	7ME4310	7ME4110	7ME4110	7ME4110	7ME4120

#### Design

Compact		•				•		•	
Remote	•	•	•	•		•	•	•	•

#### Transmitter enclosure

Polyamide, IP67/NEMA4X						•			
Noryl (SIMATIC S7-300), IP20/NEMA 2									•
Stainless steel IP67/NEMA4X								•	
19" rack IP20/NEMA2 aluminium							•		
Back of panel IP20/NEMA2 aluminium							•		
Wall mounting IP66/NEMA4 ABS plastic							•		
Front of panel IP66/NEMA4 ABS plastic							•		

#### Communication

HART						•	•	•	
PROFIBUS PA						•	•	•	
PROFIBUS DP						•	•	•	
MODBUS RTU / RS 485						•	•		•
MODBUS RTU / RS 232									•
FOUNDATION Fieldbus H1						•	•	•	
DeviceNet						•	•		

#### Supply voltage

24 V DC									•
24 V AC/DC						•	•	•	
115/230 V AC						•	•		

#### Pipe size

DI 1.5 (1/16")	•								
DI 3 (1/8")		•							
DN 4 (1/6")			•						
DI 6 (1/4")		•							
DI 15 (1/2")		•							
DN 20 (3/4")				•	•				
DN 25 (1")		•		•	•				
DN 40 (1 1/2")		•			•				
DN 50 (2")				•	•				
DN 65 (2 1/2")				•	•				
DN 80 (3")				•	•				
DN 100 (4")				•					
DN 150 (6")				•					

#### Process connection norms and pressure

##### Pipe thread

NPT ANSI/ASME B.20.1; PN 100	•	•	•						
ISO 228/1; PN 100	•	•	•						

• = available

<sup>1)</sup> Not available for DN 100 and DN 150 sensors









# SITRANS F flowmeters

## SITRANS F C

System information SITRANS F C  
Coriolis mass flowmeters

Please see Product selector  
[www.pia-selector.automation.siemens.com](http://www.pia-selector.automation.siemens.com)  
on the Internet, since  
some constraints might be related to  
some of the features



								
MASS 2100 DI 1.5	MASS 2100 DI 3 to DI 40	FC300 DN 4	MC2 DN 50 to DN 150	MC2 Hygienic DN 25 to DN 80	MASS 6000 IP67	MASS 6000 19"	MASS 6000 Ex d	SIFLOW FC070 Std/Ex
7ME4100	7ME4100, 7ME4200, 7ME4210	7ME4400	7ME4300	7ME4310	7ME4110	7ME4110	7ME4110	7ME4120

Flange									
EN 1092-1 PN 40		•		•					
EN 1092-1 PN 100		•		• <sup>1)</sup>					
ANSI B16.5 Class 150		•		•					
ANSI B16.5 Class 300				•					
ANSI B16.5 Class 600		•		• <sup>1)</sup>					
Dairy									
DIN 11851 PN 25		•		• <sup>1)</sup>	•				
DIN 11851 PN 40		•							
DIN 11864-2A					•				
Clamp ISO 2852 PN 16		•							
ISO 2853 PN 16		•							
DIN 32676 Tri-Clamp PN 10/PN 16				•	•				
Others on request	•	•	•	•	•				
Pipe material									
Stainless steel W1.4435 (316L)	•	•	•		•				
Stainless steel W1.4571 (316 Ti)				•					
Hastelloy C22	•	•	•						
Hastelloy C4				•					
With heating jacket									
Internal U - tube		•							
Pressure rating									
PN 40		•		•	•				
PN 100	•	•	•	• <sup>2)</sup>					
High-pressure version <sup>3)</sup>	•	•	•						
Accuracy									
Flow error ≤ 0.1% of rate	•	•	•	•	•				
Flow error ≤ 0.15% of rate				•	•				
Flow error ≤ 0.5% of rate				•	•				
Density error ≤ 0.0005 g/cm <sup>3</sup>		•							
Density error ≤ 0.001 g/cm <sup>3</sup>	•			•	•				
Density error ≤ 0.0015 g/cm <sup>3</sup>		• <sup>4)</sup>	•						
Cable glands									
PG 13.5						•			
½" NPT				•	•	•			
M20				•	•	•		•	

• = available

<sup>1)</sup> Not available for DN 150 sensor

<sup>2)</sup> Not available for DN 100 and DN 150 sensors

<sup>3)</sup> Please see technical specifications

<sup>4)</sup> DI 3 and DI 6

# SITRANS F flowmeters

## SITRANS F C

### System information SITRANS F C Coriolis mass flowmeters

Please see Product selector  
[www.pia-selector.automation.siemens.com](http://www.pia-selector.automation.siemens.com)  
on the Internet, since  
some constraints might be related to  
some of the features



MASS 2100 DI 1.5	MASS 2100 DI 3 to DI 40	FC300 DN 4	MC2 DN 50 to DN 150	MC2 Hygienic DN 25 to DN 80	MASS 6000 IP67	MASS 6000 19"	MASS 6000 Ex d	SIFLOW FC070 Std/Ex
7ME4100	7ME4100, 7ME4200, 7ME4210	7ME4400	7ME4300	7ME4310	7ME4110	7ME4110	7ME4110	7ME4120

#### Approvals

##### Harzardous locations

Ex II 1G EEx ia IIC T3(T4) ... T6	ATEX	●	●					
Class 1, Div 1, Group A,B,C,D Class I, Zone 0, Aex ia IIC T3 ... T6 Class I, Zone 0, Ex ia IIC T3 ... T6	C-UL	● <sup>1)</sup>	● <sup>1)</sup>					
Ex ia IIC T3/T4 ... T6	ATEX			●				
Class I, Div 1, Group A,B,C,D Class I, Zone 0, Ex ia IIC T3 ... T6	C-UL			●				
Class 1, Div 2, Groups A,B,C,D Class I, Zone 2, Aex nC IIC T4 Class I, Zone 2, Ex nC [nL] IIC T4	C-UL					● <sup>2)</sup>		
Ex II (1)G [EEx ia] IIC	ATEX						●	
Class I, Division 1 & 2, Groups A,B,C,D Class 1, Zone 2 & Zone 0, Aex nC [ia] IIC T4 Class 1, Zone 2 & Zone 0, Ex nC [ia] IIC T4	C-UL						● <sup>3)</sup>	
Ex II 2G EEx d e [ia/ib] IIC T6	ATEX							●
Ex II (1)G [Ex ia] IIC Ex II 3G Ex nA II T4	ATEX							● <sup>4)5)</sup>
Ex nA [ia] IIC T4	IECEX							● <sup>5)</sup>
Ex nA [ia] IIC T4 Class I, Zone 2, Aex nA [ia] IIC T4	uCSAus							● <sup>5)</sup>

##### Ordinary locations

USL, CNL-Flowmeter	C-UL					● <sup>2)</sup>		
USR, CNR-Flowmeter	C-UL						● <sup>6)</sup>	
USR, CNR-Flowmeter	C-UL						● <sup>7)</sup>	
USL, CNL-Flowmeter	C-UL						● <sup>8)</sup>	

##### PED

Fluid group 1 Category II, Module H	PED Directive 97/23/EC		● <sup>9)</sup>					
Module B1 + D 0/25 ... 100 bar, -80/200°C, DN 20 ... 150	PED Directive 97/23/EC			●	●			

##### CRN

Category F OF10769.5C	CRN	●	●	●				
--------------------------	-----	---	---	---	--	--	--	--

##### Pharma

EHEDG	TUM			●	●			
-------	-----	--	--	---	---	--	--	--

Note: Special conditions for safe use might be specified in certificates or operating instructions.

● = available

1) Sensor pressure max. 100 bar (1450 psi)

2) Only compact version

3) Can be placed in zone 2 if mounted in minimum IP65 cabinet

4) Can be placed in zone 2 if mounted in minimum  
IP54 cabinet

5) Only Ex version

6) 24 V; IP20

7) 115 ... 230 V; IP20

8) 115 ... 230 V; IP65

9) Only DI 25 and DI 40

# SITRANS F flowmeters

## SITRANS F C

System information SITRANS F C  
Coriolis mass flowmeters

### Function

The flow measuring principle is based on coriolis law of movement. The flowmeter consists of a sensor type MASS 2100/FC300 or MC2 and a transmitter MASS 6000/SIFLOW FC070.

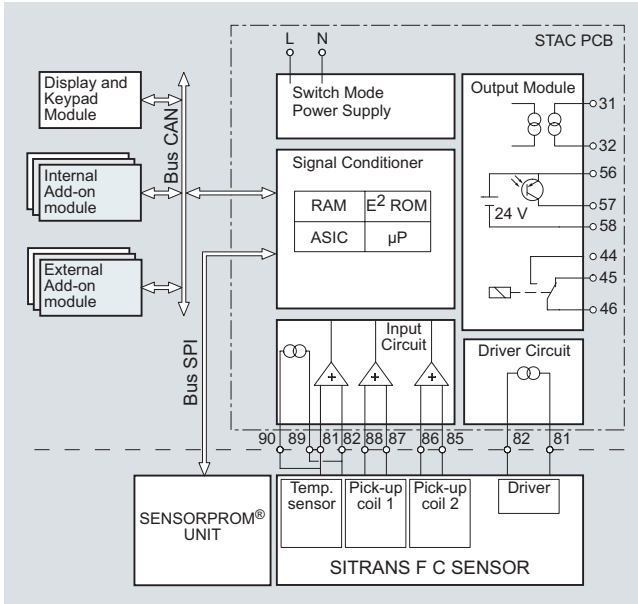

The SITRANS F C sensors are energized by an electro-mechanical driver circuit which oscillates the pipe at its resonant frequency.

Two pick-ups, 1 and 2 are placed symmetrically on both sides of the driver. When liquid or gas flows through the sensor, coriolis force will act on the measuring pipe and cause a pipe deflection which can be measured as a phase shift on pick-up 1 and 2. The phase shift is proportional to the mass flow rate.

The amplitude of the driver is automatically regulated via a „phase locked loop“, to ensure a stable output from the 2 pick-ups in the region of 80 to 110 mV.

The temperature of the sensor is measured by a Pt1000, in a wheatstone configuration (4-wire).

The flow-proportional signal from the 2 pick-ups, the temperature measurement and the driver frequency are fed into the SITRANS F C transmitter for calculations of mass, volume, fraction, temperature and density.

The analog to digital conversion takes place in an ultra-low noise ASIC with 23 bit signal resolution. The signal transfer function is based on a patented DFT technology (Discrete Fourier Transformation). The ASIC is constructed as a state machine gate array, which enables fast signal processing and filtering.

The ASIC has a built-in noise filter, which can be used to improve the meters' performance if the installation and application conditions are not ideal. Typically influence from process noise such as pump pulsations, mechanical vibrations, oscillating valves can be reduced considerably.

For communication purposes the SITRANS F C MASS 6000 transmitters have a CAN interface with a Siemens specific protocol. This concept is known as the USM II (Universal Signal Module) concept. The idea is that extra output modules or communication modules can be connected to this bus, making it possible to configure the flowmeter for the precise task in hand. When the internal CAN bus detects the installed module, it is automatically programmed to factory settings via the SENSORPROM memory unit, and the new menu is visible in the MASS 6000 display.

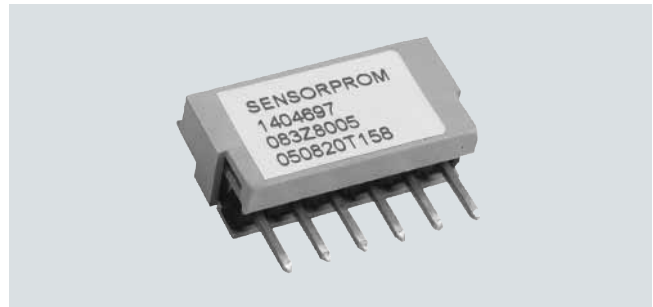

SENSORPROM flow memory unit

Currently the USM platform handles all present and future communication protocols, e.g., PROFIBUS DP, PROFIBUS PA, HART, MODBUS, FOUNDATION Fieldbus H1 and DeviceNet.

### Integration

Installation of MASS 2100/FC300 and MC2 sensors

#### Installation requirements/System design information

The SITRANS F C mass flowmeter is suitable for in- and outdoor installations. The standard instrument meets the requirements of Protection Class IP67/NEMA 4X and IP66/NEMA 4. The flowmeter is bidirectional and can be installed in any orientation. It is important to ensure that the meter tubes are always completely filled with homogeneous fluid. Otherwise measuring errors may occur.

The corrosion resistance of the fluid-wetted materials must be evaluated.

The pressure drop through the sensor is a function of the properties of the fluid and the flow rate. The **Sizing Program** (download from <https://pia.khe.siemens.com/index.aspx?nr=11501>) can be used to calculate the pressure drop.

The following points are to be considered during installation:

The preferred flow direction is indicated by the arrow on the flowmeter. Flow in this direction will be indicated as positive.

#### Installation orientation

- MASS 2100/FC300 – sensors  
The optimal installation orientation is horizontal.
- MC2 – sensors  
The optimal installation orientation is vertical with the flow upwards.

#### Supports

- In order to support the weight of the flowmeter and to ensure reliable measurements when external effects exist (e.g. vibrations), the sensor should be installed in rigid pipelines. Two supports or hangers should be installed symmetrically and stress-free in close proximity to the process connections.

#### Shut-off devices

- To conduct a system zero adjustment, shut-off devices are required in the pipeline
  - in horizontal installations at the outlet for FC300 and MC2 and the inlet for MASS 2100.
  - in vertical installations at the inlet.
- When possible, shut-off devices should be installed both up- and downstream of the flowmeter.

# SITRANS F flowmeters

## SITRANS F C

### System information SITRANS F C Coriolis mass flowmeters

#### Installation: straight run requirements

- The mass flowmeter does not require any flow conditioning straight inlet sections. Care should be exercised to ensure that any valves, gates, sight glasses etc. do not cavitate and are not set into vibration by the flowmeter.

#### System design information

- The presence of gas bubbles in the fluid may result in erroneous measurements, particularly in the density measurement. Therefore the flowmeter should not be installed at the highest point in the system. Advantageous are installations in low pipeline sections, at the bottom of a U-section in the pipeline.
- Long drop lines downstream from the flowmeter should be avoided to prevent the meter tube from draining.
- The flowmeter should not come into contact with any other objects. Avoid attachments to the housing.
- When the cross-section of the connecting pipeline is larger than the sensor size, suitable standard reducers may be installed.
- If strong vibrations exist in the pipeline, they should be damped using elastic pipeline elements. The damping devices must be installed outside the supported flowmeter section and outside the section between the shut-off devices. The direct connection of flexible elements to the sensor should be avoided.
- Make sure that any dissolved gases, which are present in many liquids, do not outgas. The back pressure at the outlet should be at least 0.1 to 0.2 bar (0.5 to 3 psi).
- Assure that operation below the vapor pressure cannot occur when a vacuum exists in the meter tube or for fluids which boil readily.
- The sensor should not be installed in the vicinity of strong electromagnetic fields, e.g. near motors, pumps, transformers etc.
- When operating more than one meter in one or multiple interconnected pipelines, the sensors should be spaced distant from each other or the pipelines should be decoupled to prevent cross talk.

#### Zero adjustment

- In order to adjust the zero under operating conditions it must be possible to reduce the flow rate to „ZERO“ while the meter tube is completely filled. A bypass line is optimal when the process cannot be shut down. It is important for accurate measurements that during the zero adjustment there are no gas bubbles in the flowmeter. It is also important that the pressure and temperature in the meter tube be the same as that which exists during operation.

#### Technical specifications

##### Flowmeter uncertainty/specifications

To ensure continuous accurate measurement, flowmeters must be calibrated. The calibration is conducted at SIEMENS flow facilities accredited according to ISO/IEC 17025 by DANAK or UKAS.

The accreditation bodies DANAK and UKAS have signed the ILAC MRA agreement (International Laboratory Accreditation Corporation - Mutual Recognition Arrangement). Therefore the accreditation ensures international traceability and recognition of the test results in 39 countries worldwide, including the US (NIST traceability).

A calibration certificate is shipped with every sensor and calibration data are stored in the SENSORPROM memory unit.

MASS 2100 sensors and MASS 6000 transmitters

	5%		50%		100%	
	kg/h	(lb/h)	kg/h	(lb/h)	kg/h	(lb/h)
<b>DI 1.5 (1/16")</b>	1	(2.2)	32.5	(71.6)	65	(140)
<b>DI 3 (1/8")</b>	12	(26)	125	(275)	250	(550)
<b>DN 4 (1/6")</b>	17.5	(38)	175	(386)	350	(770)
<b>DI 6 (1/4")</b>	50	(110)	500	(1 102)	1 000	(2 200)
<b>DI 15 (1/2")</b>	280	(617)	2 800	(6 173)	5 600	(12 345)
<b>DI 25 (1")</b>	1 250	(2 756)	12 500	(27 558)	25 000	(55 100)
<b>DI 40 (1 1/2")</b>	2 600	(5 732)	26 000	(57 320)	52 000	(114 600)

- $Q_{max}$  is found at a pressure drop of 1 bar (29 psi). With increased counterpressure  $Q_{max}$  will increase.
- For flow > 5% of the sensors max. flow rate, the error can be read directly from the curve.
- For flow < 5% of the sensors max. flow rate, use the formula to calculate the error.
- The error curve is plotted from the formula:

$$E = \pm \sqrt{(0.10)^2 + \left(\frac{Z \times 100}{qm}\right)^2}$$

E = Error [%]

Z = Zero point error [kg/h]

qm = Mass flow [kg/h]

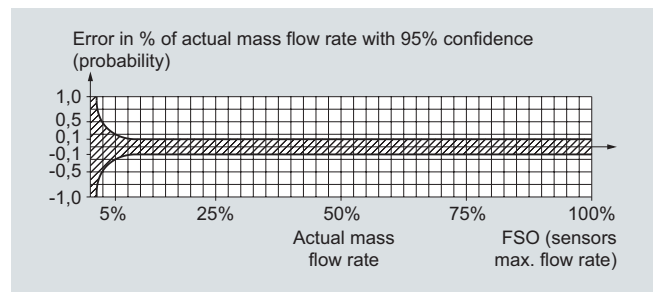

#### Reference conditions for MASS 2100 (ISO 9104 and DIN/EN 29104)

Flow conditions	Fully developed flow profile
Temperature, medium	20 °C ± 2 K (68 °F ± 3.6 °F)
Temperature, ambient	20 °C ± 2 K (68 °F ± 3.6 °F)
Liquid pressure	2 ± 1 bar
Density	0.997 g/cm <sup>3</sup>
Brix	40 °Brix
Supply voltage	$U_n \pm 1\%$
Warming-up time	30 min.
Cable length	5 m between transmitter and sensor

#### Additions in the event of deviations from reference conditions

Current output	As pulse output ± (0.1% of actual flow + 0.05% FSO)
Effect of ambient temperature	<ul style="list-style-type: none"> <li>Display/frequency/pulse output: &lt; ± 0.003% / K act.</li> <li>Current output: &lt; ± 0.005% / K act.</li> </ul>
Effect of supply voltage	< 0.005% of measuring value on 1% alteration

Sensor type		FC300	MASS 2100					
Sensor size		DN 4 (1/6")	DI 1.5 (1/16")	DI 3 (1/8")	DI 6 (1/4")	DI 15 (1/2")	DI 25 (1")	DI 40 (1 1/2")
Number of measuring pipes		1	1	1	1	1	1	1
<b>Mass flow</b>								
Linearity error	% of rate	0.10	0.10	0.10	0.10	0.10	0.10	0.10
Repeatability error	% of rate	0.05	0.05	0.05	0.05	0.05	0.05	0.05
Max. zero point error	[kg/h]	0.010	0.001	0.010	0.050	0.200	1.500	6.000
<b>Density</b>								
Density error	[g/cm <sup>3</sup> ]	0.0015	0.001	0.0015	0.0015	0.0005	0.0005	0.0005
Repeatability error	[g/cm <sup>3</sup> ]	0.0002	0.0002	0.0002	0.0002	0.0001	0.0001	0.0001
Range	[g/cm <sup>3</sup> ]	0 ... 2.9	0 ... 2.9	0 ... 2.9	0 ... 2.9	0 ... 2.9	0 ... 2.9	0 ... 2.9
<b>Temperature</b>								
Error	[°C (°F)]	0.5 (1)	0.5 (1)	0.5 (1)	0.5 (1)	0.5 (1)	0.5 (1)	0.5 (1)
<b>Brix</b>								
Error	[°Brix]	0.3	0.2	0.3	0.3	0.1	0.1	0.1
Sensor type		<b>MC2</b>						
Sensor size (standard version)		DN 50 (2")	DN 65 (2 1/2")	DN 80 (3")	DN 100 (4")	DN 150 (6")		
Sensor size (hygienic version)		DN 20 (3/4"), DN 25 (1"), DN 40 (1 1/2"), DN 50 (2")	DN 65 (2 1/2")	DN 80 (3")				
Number of measuring pipes		2	2	2	2	2		
<b>Mass flow:</b>								
Linearity error	% of rate	0.15	0.15	0.15	0.15	0.15		
Reproducibility of flowrate at rates > 5 % of Q <sub>max</sub>	% of rate	0.1	0.1	0.1	0.1	0.1		
Max. zero point error	[kg/h (lb/h)]	DN 20 0.6 (1.32), DN 25 0.96 (2.12), DN 40 2.85 (6.28), DN 50 5.52 (12.17)	11.34	14.76	24.96	330		
<b>Density</b>								
Density error	(Standard) [g/cm <sup>3</sup> ]	0.005	0.005	0.005	0.005	0.005		
	(Extended) [g/cm <sup>3</sup> ]	0.001	0.001	0.001	0.001	0.001	Not available	
Range	[kg/dm <sup>3</sup> ]	0.5 ... 3.5	0.5 ... 3.5	0.5 ... 3.5	0.5 ... 3.5	0.5 ... 3.5		
Repeatability error	[g/l]	±0.1	±0.1	±0.1	±0.1	±0.1		
<b>Temperature</b>								
Error	[°C (°F)]	1.0 (1.8)	1.0 (1.8)	1.0 (1.8)	1.0 (1.8)	1.0 (1.8)		
<b>Brix<sup>1)</sup></b>								
Error	[°Brix]	0.25	0.25	0.25	0.25	0.25	Not available	

<sup>1)</sup> Flow and density calibration (1 kg/m<sup>3</sup>) required.

# SITRANS F flowmeters

## SITRANS F C

### System information SITRANS F C Coriolis mass flowmeters

#### Flowmeter uncertainty/specifications

MC2 sensors and MASS 6000 transmitters

	5%		50%		100%	
	kg/h	(lb/h)	kg/h	(lb/h)	kg/h	(lb/h)
<b>DN 20 (¾")</b>	230	(507)	2 300	(5 071)	4 600	(10 141)
<b>DN 25 (1")</b>	368	(811)	3 680	(8 113)	7 360	(16 226)
<b>DN 40 (1½")</b>	1 093	(2 409)	10 925	(24 085)	21 850	(48 171)
<b>DN 50 (2")</b>	2 130	(4 695)	21 300	(46 958)	42 600	(93 900)
<b>DN 65 (2½")</b>	4 350	(9 590)	43 500	(95 900)	87 000	(191 800)
<b>DN 80 (3")</b>	5 670	(12 500)	56 700	(125 002)	113 400	(250 000)
<b>DN 100 (4")</b>	9 600	(21 164)	96 000	(211 643)	192 000	(423 300)
<b>DN 150 (6")</b>	25 500	(56 217)	255 000	(562 178)	510 000	(1 124 356)

Flow capacity calculated at 1 bar pressure loss on water at 20 °C

$$E = \pm \sqrt{(0.15)^2 + \left(\frac{z \times 100}{qm}\right)^2}$$

E = Error [%]

Z = Zero point error [kg/h]

qm = Mass flow [kg/h]

Q<sub>max.</sub> at 2 bar pressure loss at 1 g/cm<sup>3</sup>

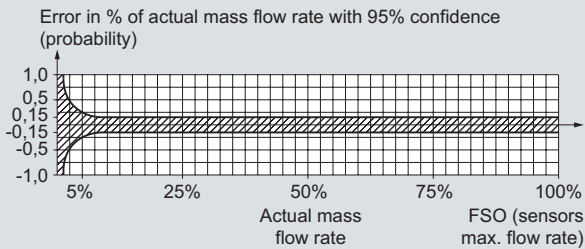



#### Technical specifications PROFIBUS PA/DP

##### General specifications

PROFIBUS device profile	3.00 Class B
Certified	Yes, according to Profile for process control devices v3.00.
MS0 connections	1
MS1 connections	1
MS2 connections	2

##### Electrical specification DP

##### Physical layer specifications

Applicable standard	EN 50170 vol. 2
Physical Layer (Transmission technology)	RS 485
Transmission speed	≤ 1.5 Mbits/s
Number of stations	Up to 32 per line segment, (maximum total of 126)

##### Cable specification (Type A)

Cable design	Two wire twisted pair
Shielding	CU shielding braid or shielding braid and shielding foil
Impedance	35 up to 165 Ω at frequencies from 3 ... 20 MHz
Cable capacity	< 30 pF per meter
Core diameter	> 0.34 mm <sup>2</sup> , corresponds to AWG 22
Resistance	< 110 Ω per km
Signal attenuation	Max. 9 dB over total length of line section
Max. bus length	200 m at 1500 kbit/s, up to 1.2 km at 93.75 kbit/s. Extendable by repeaters

##### Electrical specification PA

##### Physical layer specifications

Applicable standard	EN 50170
Physical Layer (Transmission technology)	IEC-61158-2
Transmission speed	31.25 Kbits/second
Number of stations	Up to 32 per line segment, maximum total of 126)
Max. basic current [I <sub>B</sub> ]	14 mA
Fault current [I <sub>FDE</sub> ]	0 mA
Bus voltage	9 ... 32 V (non Ex)

##### Preferred cable specification (Type A)

Cable design	Two wire twisted pair
Conductor area (nominal)	0.8 mm <sup>2</sup> (AWG 18)
Loop resistance	44 Ω/km
Impedance	100 Ω ± 20%
Wave attenuation at 39 kHz	3 dB/km
Capacitive asymmetry	2 nF/km
Bus termination	Passive line termination at both
Max. bus length	Up to 1.9 km. Extendable by repeaters

##### IS (Intrinsic Safety) data

Required sensor electronics	Compact mounted SITRANS F C MASS 6000 Ex d
FISCO	Yes
Max. U <sub>I</sub>	17.5 V
Max. I <sub>I</sub>	380 mA
Max. P <sub>I</sub>	5.32 V
Max. L <sub>I</sub>	10 μH
Max. C <sub>I</sub>	5 nF
Max. U <sub>O</sub>	1.3 V
Max. I <sub>O</sub>	50 μA

##### FISCO cable requirements

Loop resistance R <sub>C</sub>	15 ... 150 Ω/km
Loop inductance L <sub>C</sub>	0.4 ... 1 mH/km
Capacitance C <sub>C</sub>	80 ... 200 nF/km
Max. Spur length in IIC and IIB	30 m
Max. Trunk length in IIC	1 km
Max. Trunk length in IIB	5 km

##### PROFIBUS parameter support

The following parameters are accessible using a MS0 relationship from a Class 1 Master.

MS0 specifies cyclic Data Exchange between a Master and a Slave.

##### Cyclic services:

Input (Master view)	Parameter	MASS 6000
	Mass flow	✓
	Volume flow	✓
	Temperature	✓
	Density	✓
	Fraction A <sup>1)</sup>	✓
	Fraction B <sup>1)</sup>	✓
	Pct Fraction A <sup>1)</sup>	✓
	Totalizer 1	✓
	Totalizer 2 <sup>2)</sup>	✓
	Batch progress <sup>2)</sup>	✓
	Batch setpoint	✓
	Batch compensation	✓
	Batch status (running ...)	✓
Output (Master view)	Set Totalizer 1+2	✓
	Set Mode Totalizer 1+2	✓
	Batch control (start, stop ...)	✓
	Batch setpoint	✓
	Batch compensation	✓

<sup>1)</sup> Requires a SENSORPROM containing valid fraction data.

<sup>2)</sup> Value returned is dependent on the BATCH function.  
When ON, Batch progress is returned.  
When OFF, TOTALIZER 2 is returned.

# FINE CONTROLS (UK) LTD



Fine Controls have been supplying process controls & instrumentation equipment since 1994, & now serves an ever expanding customer base, both in the UK & globally.

We offer a full range of valve & instrumentation products & services, with our product range representing leading technologies & brands:

**Flow:** Flow Meters & Transmitters, Flow Switches, Flow Control Valves & Batch Control Systems

**Temperature:** Temperature Probes & Thermowells, Temperature transmitters, Temperature Regulators & Temperature Displays

**Level:** Level Transmitters & Switches

**Pressure:** Pressure Gauges & Transmitters, Precision & High Pressure Regulators & I-P Converters, Volume boosters.

**Precision Pneumatics:** Pressure Regulators, I-P Converters, Volume Boosters, Vacuum Regulators

**Valves:** Solenoid & Pneumatic Valves, Control Valves & Positioners, Actuated Ball, Globe or Diaphragm Valves & Isolation Valves

**Services:** Repair, Calibration, Panel Build, System Design & Commissioning

A rotork® Brand  
**FAIRCHILD**



**bürkert**



**SIEMENS**



**alcon**  
SOLENOID VALVES

A rotork® Brand



**MIDLAND-ACS**  
A rotork® Brand



**Honeywell**



**Bourdon**  
Baumer Group



**SOLDO**  
CONTROLS

A rotork® Brand



Fine Controls (UK) LTD, Bassendale Road, Croft Business Park,  
Bromborough, Wirral, CH62 3QL UK  
Tel: 0151 343 9966  
Email: sales@finecontrols.com