

SIEMENS

Operating Instructions

SITRANS L

Radar Transmitters

SITRANS LR120

Edition

01/2020

<https://www.siemens.com>

SIEMENS

SITRANS L

Radar Transmitters SITRANS LR120

Operating Instructions

Introduction	1
Safety notes	2
Description	3
Installing/mounting	4
Connecting	5
Access protection	6
Setup with smartphone/ tablet (Bluetooth)	7
Setup with PC/notebook (HART modem)	8
Device configuration	9
Set up with other systems	10
Diagnostics and servicing	11
Service and maintenance	12
Technical data and dimensions	13

Legal Information

Warning Notice System

This manual contains notices you have to observe in order to ensure your personal safety, as well as to prevent damage to property. The notices referring to your personal safety are highlighted in the manual by a safety alert symbol, notices referring only to property damage have no safety alert symbol. These notices shown below are graded according to the degree of danger.

 DANGER

indicates that death or severe personal injury will result if proper precautions are not taken.

 WARNING
--

indicates that death or severe personal injury may result if proper precautions are not taken.
--

 CAUTION
--

indicates that minor personal injury can result if proper precautions are not taken.
--

NOTICE

indicates that property damage can result if proper precautions are not taken.
--

If more than one degree of danger is present, the warning notice representing the highest degree of danger will be used. A notice warning of injury to persons with a safety alert symbol may also include a warning relating to property damage.

Qualified Personnel

The product/system described in this documentation may be operated only by **personnel qualified** for the specific task in accordance with the relevant documentation, in particular its warning notices and safety instructions. Qualified personnel are those who, based on their training and experience, are capable of identifying risks and avoiding potential hazards when working with these products/systems.

Proper Use of Siemens Products

Note the following:

 WARNING
--

Siemens products may only be used for the applications described in the catalog and in the relevant technical documentation. If products and components from other manufacturers are used, these must be recommended or approved by Siemens. Proper transport, storage, installation, assembly, commissioning, operation and maintenance are required to ensure that the products operate safely and without any problems. The permissible ambient conditions must be complied with. The information in the relevant documentation must be observed.
--

Trademarks

All names identified by ® are registered trademarks of Siemens AG. The remaining trademarks in this publication may be trademarks whose use by third parties for their own purposes could violate the rights of the owner.

Disclaimer of Liability

We have reviewed the contents of this publication to ensure consistency with the hardware and software described. Since variance cannot be precluded entirely, we cannot guarantee full consistency. However, the information in this publication is reviewed regularly and any necessary corrections are included in subsequent editions.

Table of Contents

1	Introduction	1
1.1	Function	1
1.2	Target group	1
1.3	Symbols used	1
2	Safety notes	3
2.1	Authorised personnel	3
2.2	Appropriate use	3
2.3	Warning about incorrect use	3
2.4	General safety instructions	3
2.5	EU conformity	4
2.6	Installation and operation in the USA and Canada	4
2.7	Safety instructions for Ex areas	4
2.8	Security information	5
3	Description	7
3.1	Configuration	7
3.2	Principle of operation	8
3.3	Adjustment	9
3.4	Packaging, transport and storage	10
3.5	Accessories	11
4	Installing/mounting	13
4.1	General instructions	13
4.2	Mounting versions	13
4.3	Mounting instructions	14
4.4	Measurement setup - Flow	17
5	Connecting	19
5.1	Preparing the connection	19
5.2	Wiring plan	20
5.3	Switch-on phase	20
6	Access protection	21
6.1	Bluetooth radio interface	21
6.2	Protection of the parameterization	21

7	Setup with smartphone/tablet (Bluetooth)	23
7.1	Connecting	23
8	Setup with PC/notebook (HART modem)	25
8.1	Saving the parameterisation data	25
9	Device configuration	27
10	Set up with other systems	31
10.1	Setup with SIMATIC PDM EDD	31
11	Diagnostics and servicing	33
11.1	Maintenance	33
11.2	Rectify faults	33
11.3	Diagnosis, fault messages	34
11.4	Status messages according to NE 107	34
11.5	Treatment of measurement errors	38
11.6	Return procedure	42
11.7	Technical support	43
11.8	How to proceed if a repair is necessary	43
12	Service and maintenance	45
12.1	Dismounting steps	45
12.2	Disposal	45
13	Technical data and dimensions	47
13.1	Technical data	47
13.2	Dimensions	51
13.3	License information for Open Source Software	51
13.4	Trademark	51

Introduction

1.1 Function

This instruction provides all the information you need for mounting, connection and setup as well as important instructions for maintenance, fault rectification, the exchange of parts and the safety of the user. Please read this information before putting the transmitter into operation and keep this manual accessible in the immediate vicinity of the device.

1.2 Target group

This operating instructions manual is directed to trained personnel. The contents of this manual must be made available to the qualified personnel and implemented.

1.3 Symbols used



Information, note, tip: This symbol indicates helpful additional information and tips for successful work.



Note: This symbol indicates notes to prevent failures, malfunctions, damage to devices or plants.



Caution: Non-observance of the information marked with this symbol may result in personal injury.



Warning: Non-observance of the information marked with this symbol may result in serious or fatal personal injury.



Danger: Non-observance of the information marked with this symbol results in serious or fatal personal injury.



Ex applications

This symbol indicates special instructions for Ex applications.



List

The dot set in front indicates a list with no implied sequence.

1

Sequence of actions

Numbers set in front indicate successive steps in a procedure.



Battery disposal

This symbol indicates special information about the disposal of batteries and accumulators.

Safety notes

2.1 Authorised personnel

All operations described in this documentation must be carried out only by trained, qualified personnel authorised by the plant operator.

During work on and with the device, the required personal protective equipment must always be worn.

2.2 Appropriate use

SITRANS LR120 is a transmitter for continuous level measurement.

You can find detailed information about the area of application in chapter "*Description*".

Operational reliability is ensured only if the transmitter is properly used according to the specifications in the operating instructions manual as well as possible supplementary instructions.

2.3 Warning about incorrect use

Inappropriate or incorrect use of this product can give rise to application-specific hazards, e.g. vessel overfill through incorrect mounting or adjustment. Damage to property and persons or environmental contamination can result. Also, the protective characteristics of the transmitter can be impaired.

2.4 General safety instructions

This is a state-of-the-art transmitter complying with all prevailing regulations and directives. The transmitter must only be operated in a technically flawless and reliable condition. The operator is responsible for the trouble-free operation of the transmitter. When measuring aggressive or corrosive media that can cause a dangerous situation if the transmitter malfunctions, the operator has to implement suitable measures to make sure the transmitter is functioning properly.

During the entire duration of use, the user is obliged to determine the compliance of the necessary occupational safety measures with the current valid rules and regulations and also take note of new regulations.

The safety instructions in this operating instructions manual, the national installation standards as well as the valid safety regulations and accident prevention rules must be observed by the user.

For safety and warranty reasons, any invasive work on the device beyond that described in the operating instructions manual may be carried out only by personnel authorised by the manufacturer. Arbitrary conversions or modifications are explicitly forbidden. For safety reasons, only the accessory specified by the manufacturer must be used.

To avoid any danger, the safety approval markings and safety tips on the device must also be observed.

The low transmitting power of the radar transmitter is far below the internationally approved limits. No health impairments are to be expected with intended use. The band range of the transmission frequency can be found in chapter "*Technical data*".

2.5 EU conformity

The device fulfils the legal requirements of the applicable EU directives. By affixing the CE marking, we confirm the conformity of the transmitter with these directives.

The EU conformity declaration can be found on our homepage.

2.6 Installation and operation in the USA and Canada

This information is only valid for USA and Canada. Hence the following text is only available in the English language.

Installations in the US shall comply with the relevant requirements of the National Electrical Code (ANSI/NFPA 70).

Installations in Canada shall comply with the relevant requirements of the Canadian Electrical Code

A Class 2 power supply unit has to be used for the installation in the USA and Canada.

2.7 Safety instructions for Ex areas

For Ex applications, only devices with corresponding Ex approval may be used. Observe the Ex-specific safety instructions. These are an integral part of the operating instructions and are enclosed with every device with Ex approval.

2.8 Security information

Siemens provides products and solutions with industrial security functions that support the secure operation of plants, systems, machines and networks.

To protect plants, systems, machines and networks against cyber threats, it is necessary to implement (and continuously maintain) a holistic, state-of-the-art industrial security concept. Siemens products and solutions constitute one element of such a concept.

Customers are responsible for preventing unauthorized access to their plants, systems, machines and networks. Such systems, machines and components should only be connected to an enterprise network or the internet if and to the extent such a connection is necessary and only when appropriate security measures (e.g. firewalls and/or network segmentation) are in place.

For additional information on industrial security measures that may be implemented, please visit <https://www.siemens.com/industrialsecurity>

Siemens products and solutions undergo continuous development to make them more secure. Siemens strongly recommends that product updates are applied as soon as they are available and that the latest product versions are used. Use of product versions that are no longer supported, and failure to apply the latest updates may increase customer's exposure to cyber threats.

To stay informed about product updates, subscribe to the Siemens Industrial Security RSS Feed under: <https://www.siemens.com/industrialsecurity>

Description

3.1 Configuration

Scope of delivery

The scope of delivery encompasses:

- SITRANS LR120 radar transmitter
- Information sheet "*Documents and software*" with:
 - Transmitter serial number
 - QR code with link for direct scanning
- Information sheet "*Device Bluetooth and Parameter Access Codes*" with:
 - Bluetooth PIN
 - Bluetooth PUK
 - Device Access PUK

The further scope of delivery encompasses:

- Documentation
 - Ex-specific "*Safety instructions*" (with Ex versions)
 - If necessary, further certificates

Note

Optional transmitter features are also described in this operating instructions manual. The respective scope of delivery results from the order specification.

Scope of this operating instructions

This operating instructions manual applies to the following transmitter versions:

- Hardware version from 1.0.0
- Software version from 1.0.0

Constituent parts

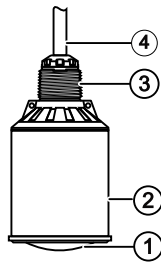

- ① Radar antenna
- ② Electronics housing
- ③ Mounting thread
- ④ Connection cable

Figure 3.1 Components of SITRANS LR120

Nameplate

The nameplate contains the most important data for identification and use of the transmitter.

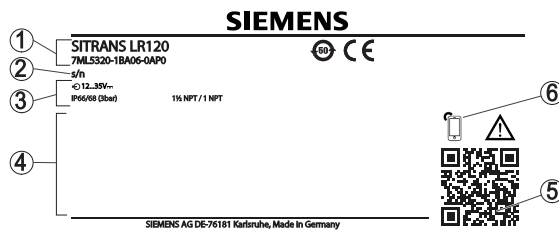

- ① Transmitter type
- ② Serial number
- ③ Technical data
- ④ Field for approvals
- ⑤ QR code for device documentation
- ⑥ Wireless access via smartphone

Figure 3.2 Layout of the nameplate (example)

3.2 Principle of operation

Application area

SITRANS LR120 is an radar transmitter for continuous level measurement. It is suitable for liquids and solids in practically all industries.

Functional principle

The transmitter emits a continuous, frequency-modulated radar signal through its antenna. The emitted signal is reflected by the medium and received by the antenna as an echo with modified frequency. The frequency change is proportional to the distance and is converted into the level.

3.3 Adjustment

Wireless adjustment

Devices with integrated Bluetooth module can be adjusted wirelessly via standard adjustment tools.

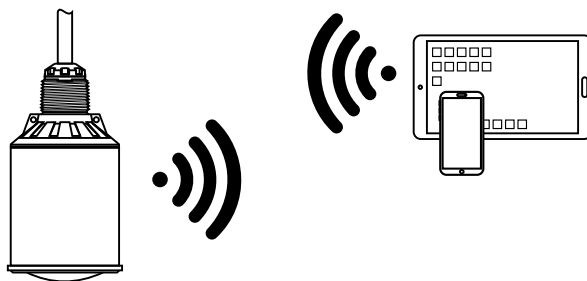

- ① Transmitter
- ② Smartphone/Tablet

Figure 3.3 Wireless connection to standard operating devices with integrated Bluetooth LE

Adjustment via the signal cable

Devices with signal output 4 ... 20 mA/HART can also be operated via a signal cable. This is done via an interface converter and a PC/notebook using SIMATIC PDM.

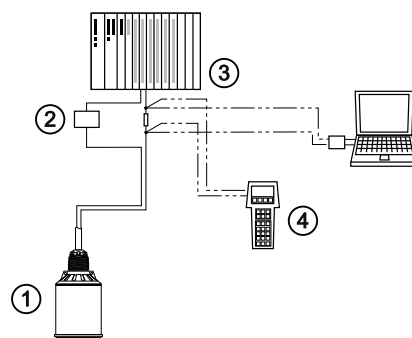

- ① Transmitter
- ② HART resistance 250 Ω (optional depending on evaluation)
- ③ Control system
- ④ Handheld

Figure 3.4 Connecting the PC to the signal cable

3.4 Packaging, transport and storage

Packaging

Your transmitter was protected by packaging during transport. Its capacity to handle normal loads during transport is assured by a test based on ISO 4180.

The packaging consists of environment-friendly, recyclable cardboard. For special versions, PE foam or PE foil is also used. Dispose of the packaging material via specialised recycling companies.

Transport

Transport must be carried out in due consideration of the notes on the transport packaging. Nonobservance of these instructions can cause damage to the device.

Transport inspection

The delivery must be checked for completeness and possible transit damage immediately at receipt. Ascertained transit damage or concealed defects must be appropriately dealt with.

Storage

Up to the time of installation, the packages must be left closed and stored according to the orientation and storage markings on the outside.

Unless otherwise indicated, the packages must be stored only under the following conditions:

- Not in the open
- Dry and dust free
- Not exposed to corrosive media
- Protected against solar radiation
- Avoiding mechanical shock and vibration

Storage and transport temperature

The permissible storage and transport temperatures can be found in chapter "*Technical data and dimensions - Technical data - Ambient conditions*"

3.5 Accessories

Mounting accessories

The optional mounting accessories include bracket and mounting bracket and are used for stable mounting of the transmitter at the measuring point. The parts are available in various versions and sizes.

Installing/mounting

4.1 General instructions

Ambient conditions

The transmitter is suitable for standard and extended ambient conditions acc. to DIN/EN/IEC/ANSI/ISA/UL/CSA 61010-1. It can be used indoors as well as outdoors.

Process conditions

 **WARNING**

For safety reasons, the transmitter must only be operated within the permissible process conditions. You can find detailed information on the process conditions in chapter "*Technical data*" of the operating instructions or on the nameplate.

Hence make sure before mounting that all parts of the transmitter exposed to the process are suitable for the existing process conditions.

These are mainly:

- Active measuring component
- Process fitting
- Process seal

Process conditions in particular are:

- Process pressure
- Process temperature
- Chemical properties of the medium
- Abrasion and mechanical influences

4.2 Mounting versions

Mounting bracket

For the wall mounting, a mounting bracket with opening for thread G1½ is recommended. The mounting of the transmitter in the bracket is carried out via a G1½ counter nut of plastic. Take note of chapter "*Mounting instructions*" for the recommended distance to the wall.

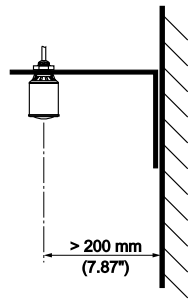

Figure 4.1 Mounting via a mounting bracket

4.3 Mounting instructions

Installation position

When mounting the transmitter, keep a distance of at least 200 mm (7.874 in) from the vessel wall. If the transmitter is installed in the center of dished or round vessel tops, multiple echoes can arise. However, these can be suppressed by an appropriate adjustment (see chapter "Setup").

If you cannot maintain this distance, you should carry out an auto false echo suppression during setup. This applies particularly if buildup on the vessel wall is expected. In such cases, we recommend repeating the auto false echo suppression at a later date with existing buildup.

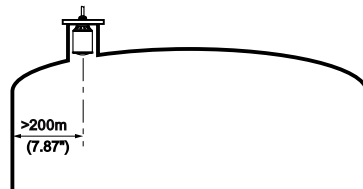
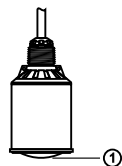

Figure 4.2 Mounting of the radar transmitter on round vessel tops

Reference point

The antenna edge of the device is the beginning of the measuring range and at the same time the reference point for the min./max. adjustment, see following diagram:



① Reference point

Figure 4.3 Reference point

Inflowing medium

Do not mount the transmitters in or above the filling stream. Make sure that you detect the product surface, not the inflowing product.

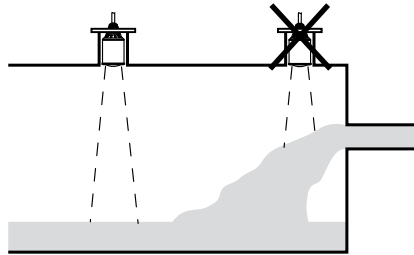

Figure 4.4 Mounting of the radar transmitter with inflowing medium

Mounting nozzle

For nozzle mounting, the nozzle should be as short as possible and its end rounded. This reduces false reflections from the nozzle.

The antenna edge should protrude at least 5 mm (0.2 in) out of the nozzle.

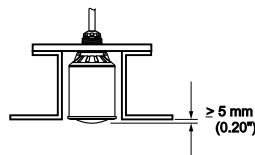

Figure 4.5 Recommended nozzle mounting of SITRANS LR120

If the reflective properties of the medium are good, you can mount SITRANS LR120 on nozzles longer than the antenna. The nozzle end should be smooth and burr-free, if possible also rounded.

Note

When mounting on longer nozzles, we recommend carrying out a auto false echo suppression (see chapter "*Parameter adjustment*").

You will find recommended values for nozzle heights in the following illustration or the table. The values come from typical applications. Deviating from the proposed dimensions, also longer nozzles are possible, however the local conditions must be taken into account.

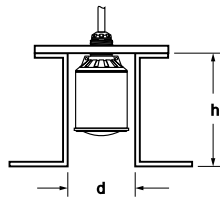

Figure 4.6 Nozzle mounting with deviating nozzle dimensions

Nozzle diameter d		Nozzle length h	
80 mm	3"	≤ 300 mm	≤ 11.8 in
100 mm	4"	≤ 400 mm	≤ 15.8 in
150 mm	6"	≤ 600 mm	≤ 23.6 in

Transmitter orientation

In liquids, direct the transmitter as perpendicular as possible to the product surface to achieve optimum measurement results.

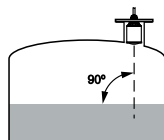

Figure 4.7 Alignment in liquids

Agitators

If there are agitators in the vessel, a auto false echo suppression should be carried out with the agitators in motion. This ensures that the interfering reflections from the agitators are saved with the blades in different positions.

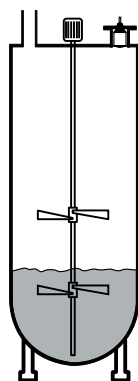

Figure 4.8 Agitators

Foam generation

Through the action of filling, stirring and other processes in the vessel, compact foams which considerably damp the emitted signals may form on the product surface.

If foams lead to measurement errors, you should use transmitters with guided radar.

4.4 Measurement setup - Flow

In general, the following must be observed while mounting the transmitter:

- Mounting the transmitter on the upstream or inlet side
- Installation in the centre of the flume and vertical to the liquid surface
- Distance to the overflow orifice or Venturi flume
- Min. distance to the max. height of damming for optimum accuracy: 250 mm (9.843 in)¹

Detailed project planning data can be found at the channel manufacturers and in the technical literature.

The following examples serve as an overview for flow measurement.

Rectangular overflow

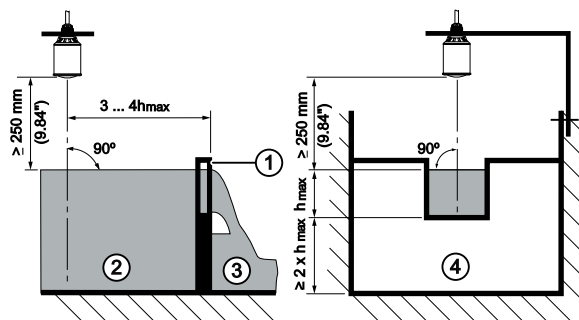

- ① Overflow orifice (side view)
- ② Head measurement
- ③ Tailwater
- ④ Overfall orifice (view from tailwater)

Figure 4.9 Flow measurement with rectangular flume: h_{\max} = max. filling of the rectangular flume

¹ At smaller distances the measuring accuracy is reduced, see Technical data.

Khafagi-Venturi flume

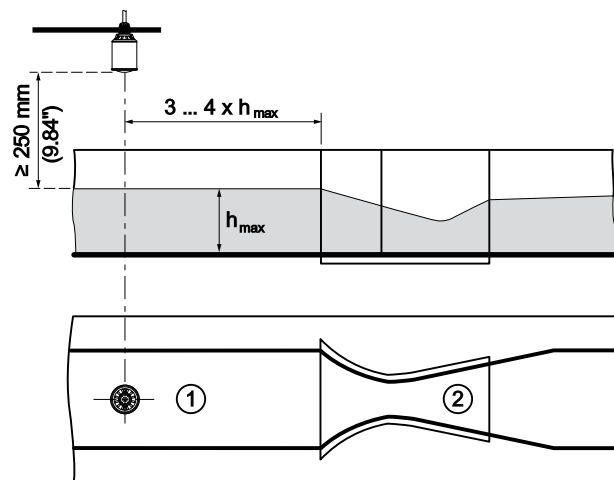

- ① Position transmitter
- ② Venturi flume

Figure 4.10 Flow measurement with Khafagi-Venturi flume: $h_{\max.}$ = max. filling of the flume; B = tightest constriction in the flume

Connecting

5.1 Preparing the connection

Safety instructions

Always keep in mind the following safety instructions:

- Carry out electrical connection by trained, qualified personnel authorised by the plant operator
- If overvoltage surges are expected, overvoltage arresters should be installed

 WARNING
--

Only connect or disconnect in de-energized state.

Voltage supply

The data for power supply are specified in chapter "*Technical data*".

 WARNING
--

Power the transmitter via an energy-limited circuit (power max. 100 W) acc. to IEC 61010-1, e.g.
--

- Class 2 power supply unit (acc. to UL1310)
- SELV power supply unit (safety extra-low voltage) with suitable internal or external limitation of the output current

Keep in mind the following additional factors that influence the operating voltage:

- Lower output voltage of the power supply unit under nominal load (e.g. with a transmitter current of 20.5 mA or 22 mA in case of fault)
- Influence of additional transmitters in the circuit (see load values in chapter "*Technical data*")

Connection cable

The transmitter is connected with standard two-wire cable. If electromagnetic interference is expected which is above the test values of EN 61326-1 for industrial areas, screened cable should be used.

Screened cable generally necessary in HART multidrop mode.

Cable screening and grounding

If shielded cable is required, we recommend that the cable screening be connected to ground potential on one side of the supply side.

In Ex systems, the grounding is carried out according to the installation regulations.

5.2 Wiring plan

Wire assignment, connection cable

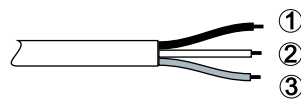

Figure 5.1 Wire assignment in permanently connected connection cable

	Wire colour	Function	Polarity
1	Black	Voltage supply, signal output	+
2	White	Voltage supply, signal output	-
3		Shielding	

5.3 Switch-on phase

After connection to the power supply, the device carries out a self-test:

- Internal check of the electronics
- Output signal is set to failure

The current measured value is then output on the signal cable.

Access protection

6.1 Bluetooth radio interface

Devices with a Bluetooth radio interface are protected against unwanted access from outside. This means that only authorized persons can receive measured and status values and change device settings via this interface.

Bluetooth PIN

A Bluetooth PIN is required to establish Bluetooth communication via the adjustment tool (smartphone/tablet/notebook). This code must be entered once when Bluetooth communication is established for the first time in the adjustment tool. It is then stored in the adjustment tool and does not have to be entered again.

The Bluetooth PIN is individual for each device. It is supplied with the device in the information sheet "*Device Bluetooth and Parameter Access Codes*". It can be changed by the user after the first connection has been established. If the Bluetooth PIN has not been entered correctly, a new entry can only be made after a waiting period has elapsed. The waiting time increases with each additional incorrect entry.

Bluetooth PUK

The Bluetooth PUK enables Bluetooth communication to be established in the event that the Bluetooth PIN is no longer known. It can't be changed. The Bluetooth PUK can be found in information sheet "*Device Bluetooth and Parameter Access Codes*". If this document is lost, the Bluetooth PUK can be retrieved from your personal contact person after legitimation. The storage and transmission of Bluetooth access codes is always encrypted (SHA 256 algorithm).

6.2 Protection of the parameterization

The settings (parameters) of the device can be protected against unwanted changes. The parameter protection is deactivated on delivery, all settings can be made.

User PIN

To protect the parameterization, the device can be locked by the user with the aid of a freely selectable user PIN. The settings (parameters) can then only be read out, but not changed. The user PIN is also stored in the adjustment tool. However, unlike the Bluetooth PIN, it must be re-entered for each unlock. When using the adjustment app or EDD, the stored user PIN is then suggested to the user for unlocking.

Device Access PUK

The Device Access PUK allows unlocking the device in case the user PIN is no longer known. It can't be changed. The Device Access PUK can also be found on the supplied information sheet "*Device Bluetooth and Parameter Access Codes*". If this document is lost, the Device Access PUK can be retrieved from your personal contact person after legitimation. The storage and transmission of the user PINs is always encrypted (SHA 256 algorithm).

Setup with smartphone/tablet (Bluetooth)

7.1 Connecting

Connecting

Start the adjustment app. The smartphone/tablet searches automatically for Bluetooth-capable transmitters in the area.

The devices found are listed.

Select the requested transmitter in the device list.

Authenticate

For the first connection, the adjustment tool and the transmitter must authenticate each other. After successful authentication, the next connection functions without authentication.

iOS

During the pairing process, the following message is displayed: "*Pairing request (Bluetooth), e.g. 12345678 wants to pair with your iPad/iPhone*". Press "Pair".

Android

The coupling passes through automatically.

Enter Bluetooth access code

For authentication, enter the 6-digit Bluetooth PIN in the next menu window. You can find the code and on the information sheet "*Device Bluetooth and Parameter Access Codes*" in the device packaging.

Note

If an incorrect code is entered, the code can only be entered again after a delay time. This time gets longer after each incorrect entry.

Connected

After connection, the transmitter adjustment menu is displayed on the respective adjustment tool.

Setup with PC/notebook (HART modem)

8.1 Saving the parameterisation data

We recommend documenting or saving the parameterisation data via SIMATIC PDM. That way the data are available for multiple use or service purposes.

8.1 Saving the parameterisation data

Device configuration

To configure the device:



1. Download and install the *SITRANS mobile IQ* app from the App store to your mobile device.
2. Launch the app. Devices in range will appear.



3. Click on the device you wish to connect to. On first connection, a PIN code shipped with the device needs to be entered (see *Device Bluetooth and Param-*

ter Access Codes sheet). Following successful PIN entry, the device cockpit will be shown.

The screenshot displays the 'Device cockpit' for a SITRANS LR110. At the top, the status bar shows the time 6:15, signal strength, Wi-Fi, and 100% battery. Below the status bar, the device name 'SITRANS LR110' is shown on the left, and 'DISCONNECT' with a menu icon on the right. The main content area is titled 'Device cockpit' and contains the following information:

	Product name SITRANS LR110/120	Tag
Serial number JNB/L8260000091	FW version 1.0.1	HW version 1.1.0
Device status		
Current values		
Level 12.100 m	Distance 2.899 m	Confidence 43 dB
Loop current 17.828 mA	Percent of range 86.429 %	

- Use the Setup/Quick Commissioning to configure the transmitter for your application type.

10:47
📶 97% 🔋

← Setup > Quick commissioning
☰

Units	m
Lower calibration point 1	15 m ▼
Upper calibration point 2	0 m ▼
Operation	Level ▼
Material type	Liquids ▼
Application	Liquid Process ▼

Many diagnostic tools are supported, including the echo profile viewer:

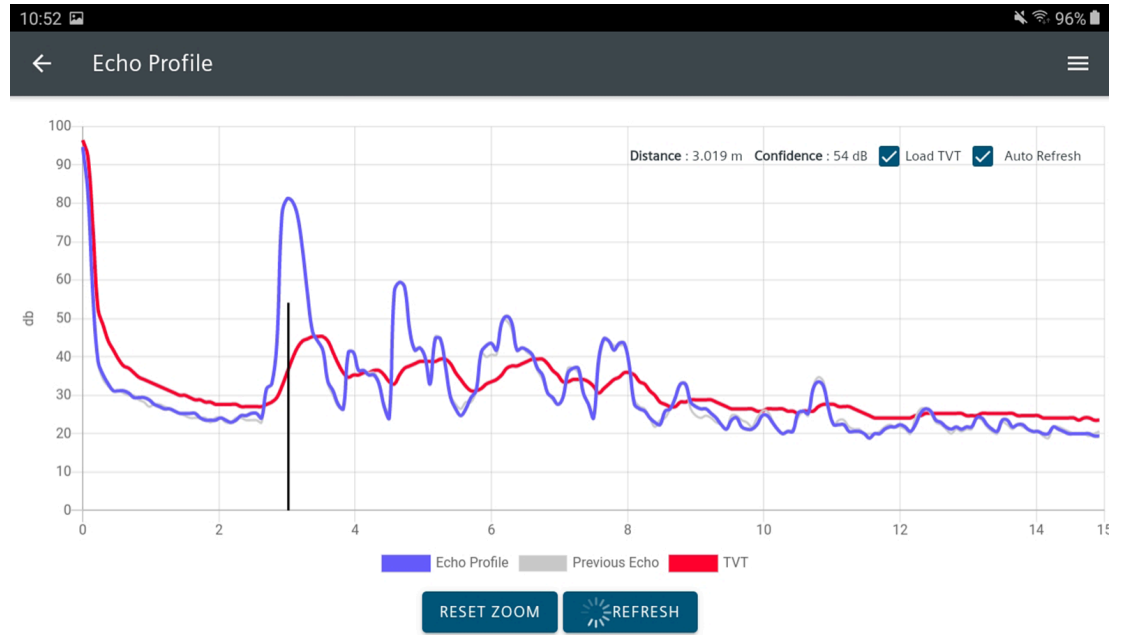

Set up with other systems

10.1 Setup with SIMATIC PDM EDD

Device descriptions as Enhanced Device Description (EDD) are available for DD adjustment programs such as for example PDM.

Diagnostics and servicing

11.1 Maintenance

Maintenance

If the device is used properly, no special maintenance is required in normal operation.

Precaution measures against buildup

In some applications, buildup on the antenna system can influence the measuring result. Depending on the transmitter and application, take measures to avoid heavy soiling of the antenna system. If necessary, clean the antenna system in certain intervals.

Cleaning

The cleaning helps that the nameplate and markings on the transmitter are visible.

Take note of the following:

- Use only cleaning agents which do not corrode the housings, nameplate and seals
- Use only cleaning methods corresponding to the housing protection rating

11.2 Rectify faults

Reaction when malfunction occurs

The operator of the system is responsible for taking suitable measures to rectify faults.

Causes of malfunction

The device offers maximum reliability. Nevertheless, faults can occur during operation. These may be caused by the following, e.g.:

- Transmitter
- Process
- Voltage supply

- Signal processing

Fault rectification

The first measures are:

- Evaluation of fault messages
- Checking the output signal
- Treatment of measurement errors

A smartphone/tablet with the adjustment app or a PC/notebook with the PDM and the suitable EDD offer you further comprehensive diagnostic possibilities. In many cases, the causes can be determined in this way and the faults eliminated.

Reaction after fault rectification

Depending on the reason for the fault and the measures taken, the steps described in chapter "Setup" must be carried out again or must be checked for plausibility and completeness.

11.3 Diagnosis, fault messages

4 ... 20 mA signal

Connect a multimeter in the suitable measuring range according to the wiring plan. The following table describes possible errors in the current signal and helps to eliminate them:

Error	Cause	Rectification
4 ... 20 mA signal not stable	Fluctuating measured value	Set damping
4 ... 20 mA signal missing	Electrical connection faulty	Check connection, correct, if necessary
	Voltage supply missing	Check cables for breaks; repair if necessary
	Operating voltage too low, load resistance too high	Check, adapt if necessary
Current signal greater than 22 mA, less than 3.6 mA	Transmitter electronics defective	Replace device or send in for repair depending on device version

11.4 Status messages according to NE 107

The transmitter features self-monitoring and diagnostics according to NE 107 and VDI/VDE 2650. In addition to the status messages in the following tables there are more detailed error messages available under the menu item "Diagnostics" via the respective adjustment module.

Status messages

The status messages are divided into the following categories:

- Failure
- Function check
- Out of specification
- Maintenance requirement

and explained by pictographs:

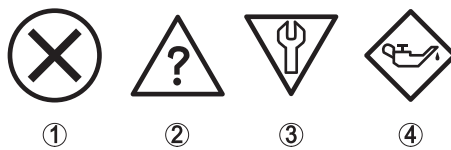

- ① Failure - red
- ② Out of specification - yellow
- ③ Function check - orange
- ④ Maintenance - blue

Figure 11.1 Pictographs of the status messages

Failure: Due to a malfunction in the transmitter, a fault message is output.

This status message is always active. It cannot be deactivated by the user.

Function check: The transmitter is being worked on, the measured value is temporarily invalid (for example during simulation).

This status message is inactive by default.

Out of specification: The measured value is unreliable because an transmitter specification was exceeded (e.g. electronics temperature).

This status message is inactive by default.

Maintenance: Due to external influences, the transmitter function is limited. The measurement is affected, but the measured value is still valid. Plan in maintenance for the transmitter because a failure is expected in the near future (e.g. due to buildup).

This status message is inactive by default.

Failure

Code Text message	Cause	Rectification	DevSpec State in CMD 48
F013 no measured value available	No measured value in the switch-on phase or during operation	Check or correct installation and/or parameter settings Clean the antenna system	Byte 5, Bit 0 of Byte 0 ... 5

Code Text message	Cause	Rectification	DevSpec State in CMD 48
F017 Adjustment span too small	Adjustment not within specification	Change adjustment according to the limit values (difference between min. and max. ≥ 10 mm)	Byte 5, Bit 1 of Byte 0 ... 5
F025 Error in the linearization table	Index markers are not continuously rising, for example illogical value pairs	Check linearisation table Delete table/Create new	Byte 5, Bit 2 of Byte 0 ... 5
F036 No operable software	Checksum error if software update failed or aborted	Repeat software update Send transmitter for repair	Byte 5, Bit 3 of Byte 0 ... 5
F040 Error in the electronics	Limit value exceeded in signal processing Hardware error	Restart transmitter Send transmitter for repair	Byte 5, Byte 5, Bit 4 of Byte 0 ... 5
F080 General software error	General software error	Restart transmitter	Byte 5, Byte 5, Bit 5 of Byte 0 ... 5
F105 Determine measured value	The transmitter is still in the start phase, the measured value could not yet be determined	Wait for the end of the switch-on phase Duration up to 3 minutes depending on the measurement environment and parameter settings	Byte 5, Byte 5, Bit 6 of Byte 0 ... 5
F260 Error in the calibration	Checksum error in the calibration values Error in the EEPROM	Send transmitter for repair	Byte 4, Bit 0 of Byte 0 ... 5
F261 Error in the transmitter settings	Error during setup Auto false echo suppression faulty Error when carrying out a reset	Repeat setup Carry out a reset	Byte 4, Bit 1 of Byte 0 ... 5
F265 Measurement function disturbed	Program sequence of the measuring function disturbed	Device restarts automatically	Byte 4, Bit 3 of Byte 0 ... 5

Function check

Code Text message	Cause	Rectification	DevSpec State in CMD 48
C700 Simulation active	A simulation is active	Finish simulation Wait for the automatic end after 60 mins.	"Simulation Active" in "Standardized Status 0"

Out of specification

Code Text message	Cause	Rectification	DevSpec State in CMD 48
S600 Impermissible electronics temperature	Temperature of the electronics in the non-specified range	Check ambient temperature Insulate electronics	Byte 23, Bit 4 of Byte 14 ... 24
S601 Overfilling	Danger of vessel overflowing	Make sure that there is no further filling Check level in the vessel	Byte 23, Bit 5 of Byte 14 ... 24
S603 Impermissible operating voltage	Terminal voltage too small	Check terminal voltage, increase operating voltage	Byte 23, Bit 6 of Byte 14 ... 24

Maintenance

Code Text message	Cause	Rectification	DevSpec State in CMD 48
M500 Error in the delivery status			Bit 0 of Byte 14 ... 24
M501 Error in the delivery status			Bit 1 of Byte 14 ... 24
M504 Error at a device interface	Hardware defect	Check connections Exchanging the electronics Send transmitter for repair	Bit 4 of Byte 14 ... 24
M505 No echo available	Transmitter does not detect an echo during operation Antenna dirty or defective	Clean the antenna Use a more suitable antenna/transmitter Remove possible false echoes Optimize transmitter position and orientation	Bit 5 of Byte 14 ... 24
M507 Error in the transmitter settings	Error during setup Error when carrying out a reset Auto false echo suppression faulty	Carry out reset and repeat setup	Bit 7 of Byte 14 ... 24
M508 Data error in program memory Bluetooth controller			Bit 8 of Byte 14 ... 24
M509 Software update			Bit 9 of Byte 14 ... 24

Code Text message	Cause	Rectification	DevSpec State in CMD 48
M510 No communication with the transmitter			Bit 10 of Byte 14 ... 24

11.5 Treatment of measurement errors

The tables below give typical examples of application-related measurement errors.

The images in column "Error description" show the actual level as a dashed line and the output level as a solid line.

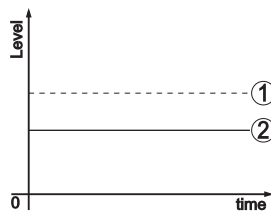





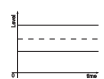
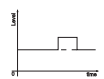

- ① Real level
- ② Level displayed by the transmitter

Note





If the output level is constant, the cause could also be the fault setting of the current output to "Hold value".

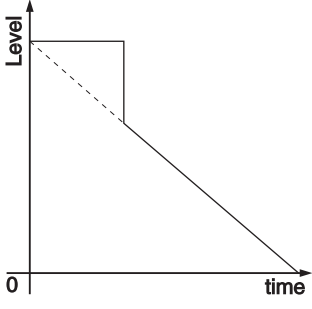
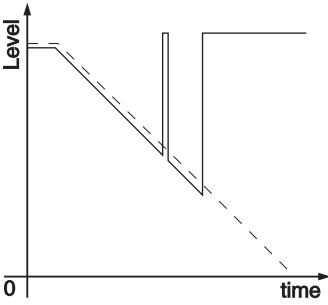

If the level is too low, the reason could be a line resistance that is too high

Fault description	Cause	Rectification
Measured value shows a too low or too high level 	Min./max. adjustment not correct	Adapt min./max. adjustment
	Incorrect linearisation curve	Adapt linearisation curve
Measured value jumps towards 100 % 	Due to the process, the amplitude of the level echo sinks A auto false echo suppression was not carried out	Carry out a auto false echo suppression
	Amplitude or position of a false signal has changed (e.g. condensation, buildup); auto false echo suppression no longer matches actual conditions	Determine the reason for the changed false signals, carry out auto false echo suppression, e.g. with condensation.
Fault description	Cause	Rectification
Measured value remains unchanged during filling	False signals in the close range too big or level echo too small Strong foam or spout generation	Eliminate false signals in the close range

Fault description	Cause	Rectification
	Max. adjustment not correct	<p>Check measuring point: Antenna should protrude out of the threaded mounting nozzle, possible false echoes through flange nozzle?</p> <p>Remove contamination on the antenna</p> <p>In case of interferences due to installations in the close range, change polarisation direction</p> <p>Create a new auto false echo suppression</p> <p>Adapt max. adjustment</p>
<p>Measured value jumps towards 0 % during filling</p> 	The level echo cannot be distinguished from the false signal at a false signal position (jumps to multiple echo)	<p>In case of interferences due to installations in the close range: Change polarisation direction</p> <p>Chose a more suitable installation position</p>
<p>Measured value jumps towards 100 % during filling</p> 	Due to strong turbulence and foam generation during filling, the amplitude of the level echo sinks. Measured value jumps to false signal	Carry out a auto false echo suppression
<p>Measured value jumps sporadically to 100 % during filling</p> 	Varying condensation or contamination on the antenna	Carry out a auto false echo suppression or increase auto false echo suppression with condensation/contamination in the close range by editing
<p>Measured value jumps to ≥ 100 % or 0 m distance</p> 	Level echo is no longer detected in the close range due to foam generation or false signals in the close range. The transmitter goes into overfill protection mode. The max. level (0 m distance) as well as the status message "Overfill protection" are output.	<p>Check measuring point: Antenna should protrude out of the threaded mounting nozzle, possible false echoes through flange nozzle?</p> <p>Remove contamination on the antenna</p>

Fault description	Cause	Rectification
<p>Measured value remains unchanged in the close range during emptying</p>	<p>False signal larger than the level echo</p> <p>Level echo too small</p>	<p>Check measuring point: Antenna should protrude out of the threaded mounting nozzle, possible false echoes through flange nozzle?</p> <p>Remove contamination on the antenna</p> <p>In case of interferences due to installations in the close range: Change polarisation direction</p>

Fault description	Cause	Rectification
		After eliminating the false signals, the auto false echo suppression must be deleted. Carry out a new auto false echo suppression
<p>Measured value jumps sporadically towards 100 % during emptying</p> 	Varying condensation or contamination on the antenna	Carry out auto false echo suppression or increase auto false echo suppression in the close range by editing
Fault description	Cause	Rectification
<p>Measured value shows a too low or too high level</p> 	Min./max. adjustment not correct	Adapt min./max. adjustment
	Incorrect linearisation curve	Adapt linearisation curve
<p>Measured value jumps towards 100 %</p> 	<p>Due to the process, the amplitude of the product echo decreases</p> <p>A auto false echo suppression was not carried out</p>	Carry out a auto false echo suppression
	Amplitude or position of a false signal has changed (e.g. condensation, buildup); auto false echo suppression no longer matches actual conditions	Determine the reason for the changed false signals, carry out auto false echo suppression, e.g. with condensation.
Fault description	Cause	Rectification
<p>Measured value jumps towards 0 % during filling</p> 	The level echo cannot be distinguished from the false signal at a false signal position (jumps to multiple echo)	<p>Remove/reduce false signal: minimize interfering installations by changing the polarization direction</p> <p>Chose a more suitable installation position</p>

Fault description	Cause	Rectification
	Transverse reflection from an extraction funnel, amplitude of the transverse reflection larger than the level echo	Direct transmitter to the opposite funnel wall, avoid crossing with the filling stream
Measured value fluctuates around 10 ... 20 % 	Various echoes from an uneven product surface, e.g. a material cone	Check parameter "Material Type" and adapt, if necessary Optimize installation position and transmitter orientation
	Reflections from the product surface via the vessel wall (deflection)	Select a more suitable installation position, optimize transmitter orientation, e.g. with a swivelling holder
Measured value jumps sporadically to 100 % during filling 	Changing condensation or contamination on the antenna	Carry out a auto false echo suppression or increase auto false echo suppression with condensation/contamination in the close range by editing

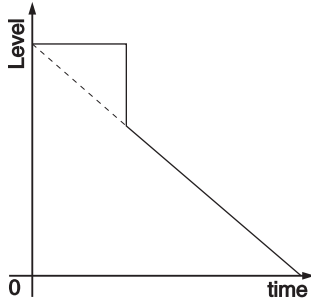
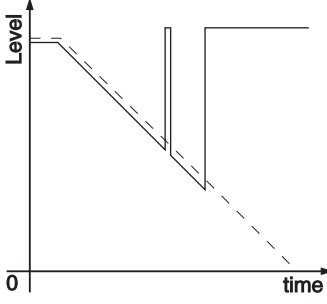
Fault description	Cause	Rectification
Measured value remains unchanged in the close range during emptying 	False signal greater than level echo or level echo too small	Eliminate false signals in the close range. Check: Antenna must protrude out of the nozzle Remove contamination on the antenna Minimize interfering installations in the close range by changing the polarization direction After eliminating the false signals, the auto false echo suppression must be deleted. Carry out a new auto false echo suppression
Measured value jumps sporadically towards 100 % during emptying 	Changing condensation or contamination on the antenna	Carry out auto false echo suppression or increase auto false echo suppression in the close range by editing
Measured value fluctuates around 10 ... 20 %	Various echoes from an uneven product surface, e.g. an extraction funnel	Check parameter "Material Type" and adapt, if necessary

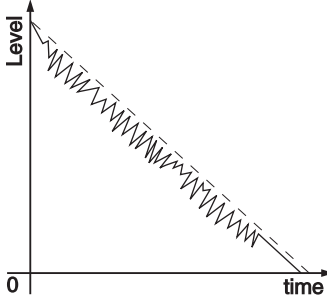
Fault description	Cause	Rectification
	Reflections from the product surface via the vessel wall (deflection)	Optimize installation position and transmitter orientation

11.6 Return procedure

Enclose the delivery note, the return goods delivery note and the decontamination declaration in a clear plastic pouch and attach it firmly to the outside of the packaging. Any devices/replacement parts which are returned without a decontamination declaration will be cleaned at your expense before further processing.

Required forms:

- Delivery note
- Return goods delivery note with the following information: <https://www.siemens.com/processinstrumentation/returngoodsnote>
 - Product (item description)
 - Number of returned devices/replacements parts
 - Reason for returning the item(s)
- Decontamination declaration
 - <https://www.siemens.com/sc/declarationofdecontamination>

With this declaration you warrant "that the device/replacement part has been carefully cleaned and is free of residues. The device/replacement part does not pose a hazard for humans and the environment."

If the returned device/replacement part has come into contact with poisonous, corrosive, flammable or water-contaminating substances, you must thoroughly clean and decontaminate the device/replacement part before returning it in order to ensure that all hollow areas are free from hazardous substances. Check the item after it has been cleaned.

Any devices/replacement parts returned without a decontamination declaration will be cleaned at your expense before further processing.

11.7 Technical support

Technical Support

If this documentation does not provide complete answers to any technical questions you may have, contact technical support at <http://www.siemens.com/automation/support-request>.

More information about our technical support is available at <http://www.siemens.com/automation/csi/service>

Internet service and support

In addition to our documentation, Siemens provides a comprehensive support solution at <http://www.siemens.com/automation/service&support>

Contact person

If you have additional questions about the device, please contact your Siemens personal contact at <http://www.automation.siemens.com/partner>

To find the personal contact for your product, go to "All products and Branches" and select "Products and services > Industrial automation > Process instrumentation".

Documentation

Documentation on the various products and systems can be found at <http://www.siemens.com/processinstrumentation/documentation>.

Certificates

You can find certificates in the Internet under <http://www.siemens.com/processinstrumentation/certificates> or on an included DVD.

11.8 How to proceed if a repair is necessary

If it is necessary to repair the transmitter, please contact Siemens. You find the locations on "www.siemens.com/processautomation [<https://www.siemens.com/processautomation>]".

Service and maintenance

12.1 Dismounting steps

 **WARNING**

Before dismounting, be aware of dangerous process conditions such as e.g. pressure in the vessel or pipeline, high temperatures, corrosive or toxic media etc.

Take note of chapters "*Installing/mounting*" and "*Connecting to voltage supply*" and carry out the listed steps in reverse order.

12.2 Disposal



The device is made of recyclable materials. For this reason, it should be disposed of by a specialist recycling company. Observe the applicable national regulations.

Devices described in this manual should be recycled. They may not be disposed of in the municipal waste disposal services according to the Directive 2012/19/EC on waste electronic and electrical equipment (WEEE).

Devices can be returned to the supplier within the EC, or to a locally approved disposal service for eco-friendly recycling. Observe the specific regulations valid in your country.

Further information about devices containing batteries can be found at: (<https://support.industry.siemens.com/cs/document/109479891/>)

Note

Special disposal required

The device includes components that require special disposal.

- Dispose of the device properly and environmentally through a local waste disposal contractor.
-

Technical data and dimensions

13.1 Technical data

Note for approved transmitters

Device specifications:

Siemens makes every effort to ensure the accuracy of these specifications, but reserves the right to change them at any time.

Device-specific approvals:

The device-specific approvals are always to be found on the type plates on the device.

Materials and weights

Mounting connection	Thread R1" or 1" NPT
----------------------------	----------------------

Materials, wetted parts

Antenna	PVDF
Counter nut (depending on device version)	PP

Materials, non-wetted parts

Housing	PVDF
Cable entry seal	NBR
Connection cable	PVC

Weight

Transmitter	0.7 kg (1.543 lbs)
Connection cable	0.1 kg/m

Torques

Torque counter nut max.	7 Nm (5.163 lbf ft)
--------------------------------	---------------------

13.1 Technical data

Input variable

Measured variable	The measured variable is the distance between the antenna edge of the transmitter and the product surface. The antenna edge is also the reference point for the measurement.
Max. measuring range^a	30 m (98.43 ft)

^a Depending on application and medium

Switch-on phase

Start-up time with operating voltage U_B	< 10 s
Starting current (for run-up time)	≤ 3.6 mA

Output variable

Output signal	4 ... 20 mA/HART
Range of the output signal	3.8 ... 20.5 mA/HART (default setting)
Signal resolution	0.3 μA
Resolution, digital	1 mm (0.039 in)
Fault signal, current output (adjustable)	mA-value unchanged 20.5 mA, 22 mA, < 3.6 mA
Max. output current	22 mA
Starting current	≤ 3.6 mA; ≤ 10 mA for 5 ms after switching on
Load	See load resistance under Power supply
Damping (63 % of the input variable), adjustable	0 ... 999 s
Fulfilled HART specification	7.0
Further information on Manufacturer ID, Device ID, Device Revision	See website of HART Communication Foundation

HART output values according to HART 7.0²

PV (Primary Value)	Lin. percent
SV (Secondary Value)	Distance
TV (Third Value)	Measurement reliability
QV (Fourth Value)	Electronics temperature

² Default values can be assigned individually.

Deviation (according to DIN EN 60770-1)

Deviation with liquids	≤ 2 mm (meas. distance > 0.25 m/0.8202 ft)
Non-repeatability^a	≤ 2 mm
Deviation with bulk solids	The values depend to a great extent on the application. Binding specifications are thus not possible.

^a Already included in the meas. deviation

Process reference conditions according to DIN EN 61298-1

Temperature	+18 ... +30 °C (+64 ... +86 °F)
Relative humidity	45 ... 75 %
Air pressure	860 ... 1060 mbar/86 ... 106 kPa (12.5 ... 15.4 psig)

Installation reference conditions

Distance to installations	> 200 mm (7.874 in)
Reflector	Flat plate reflector
False reflections	Biggest false signal, 20 dB smaller than the useful signal

Variables influencing measurement accuracy

Specifications apply to the digital measured value

Specifications apply also to the current output

Temperature drift - Digital output	< 3 mm/10 K, max. 10 mm
Temperature drift - Current output	< 0.03 %/10 K or max. 0.3 % relating to the 16.7 mA span
Deviation in the current output due to digital/analogue conversion	< 15 µA

Additional deviation through electromagnetic interference

According to NAMUR NE 21	< 80 µA
According to EN 61326-1	None
According to IACS E10 (shipbuilding)/IEC 60945	< 250 µA

Characteristics and performance data

Measuring frequency	W-band (80 GHz technology)
Measuring cycle time^a	≤ 250 ms
Step response time^b	≤ 3 s

13.1 Technical data

Beam angle^c	4°
-------------------------------	----

^a With operating voltage $U_B \geq 24$ V DC

^b Time span after a sudden distance change from 1 m to 5 m until the output signal reaches 90 % of the final value for the first time (IEC 61298-2). Valid with operating voltage $U_B \geq 24$ V DC.

^c Outside the specified beam angle, the energy level of the radar signal is 50% (-3 dB) less.

Ambient conditions

Ambient temperature	-40 ... +80 °C (-40 ... +176 °F)
Storage and transport temperature	-40 ... +80 °C (-40 ... +176 °F)

Mechanical environmental conditions

Sinusoidal vibrations	Class 4M8 acc. to IEC 60271-3-4
Impacts	50 g, 2.3 ms acc. to IEC 60271-3-6 (mechanical shock)
Impact resistance	IK07 acc. to IEC 62262

Process conditions

For the process conditions, please also note the specifications on the nameplate. The lowest value (amount) always applies.

Process temperature	-40 ... +80 °C (-40 ... +176 °F)
Process pressure	-1 ... 3 bar (-100 ... 200 kPa/-14.5 ... 43.51 psig)

Bluetooth interface

Bluetooth standard	Bluetooth 5.0 (downward compatible to Bluetooth 4.0 LE)
Frequency	2.402 ... 2.480 GHz
emitted power max.	+4dBm
Max. number of participants	1
Max. effective range^a	25 m (82 ft)

^a Depending on the local conditions

Voltage supply

Operating voltage U_B	12 ... 35 V DC
Reverse voltage protection	Integrated

Electrical protective measures

Protection rating	IP66/IP68 (3 bar) acc. to IEC 60529, Type 4P acc. to UL 50
--------------------------	--

Altitude above sea level	5000 m (16404 ft)
Protection class	III
Pollution degree	4

13.2 Dimensions

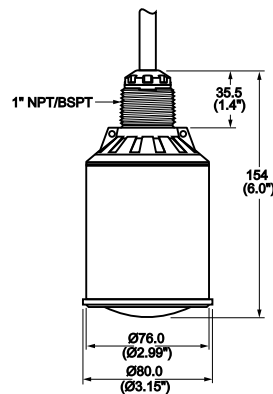

Figure 13.1 Dimensions SITRANS LR120

13.3 License information for Open Source Software

Hashfunction acc. to mbed TLS: Copyright (C) 2006-2015, ARM Limited, All Rights Reserved
 SPDX-License-Identifier: Apache-2.0

Licensed under the Apache License, Version 2.0 (the "License"); you may not use this file except in compliance with the License. You may obtain a copy of the License at <http://www.apache.org/licenses/LICENSE-2.0>.

Unless required by applicable law or agreed to in writing, software distributed under the License is distributed on an "AS IS" BASIS, WITHOUT WARRANTIES OR CONDITIONS OF ANY KIND, either express or implied. See the License for the specific language governing permissions and limitations under the License.

13.4 Trademark

All the brands as well as trade and company names used are property of their lawful proprietor/originator.

13.4 Trademark

Further Information

Process Automation

<https://www.siemens.com/processautomation>

Industry Online Support (service and support)

<https://support.industry.siemens.com>

Industry Mall

<https://mall.industry.siemens.com>

Siemens AG

Digital Industry

Process Automation

Postfach 48 48

90026 NÜRNBERG

GERMANY