

SIEMENS

SITRANS F

Coriolis Flowmeters SITRANS FC330

Compact Operating Instructions

<u>Introduction</u>	1
<u>Safety notes</u>	2
<u>Installing/mounting</u>	3
<u>Connecting</u>	4
<u>Commissioning</u>	5
<u>Service and maintenance</u>	6
<u>Technical data</u>	7
<u>Certificates and support</u>	A

7ME4633 (SITRANS FC330)

Legal information

Warning notice system

This manual contains notices you have to observe in order to ensure your personal safety, as well as to prevent damage to property. The notices referring to your personal safety are highlighted in the manual by a safety alert symbol, notices referring only to property damage have no safety alert symbol. These notices shown below are graded according to the degree of danger.

! DANGER
indicates that death or severe personal injury will result if proper precautions are not taken.

! WARNING
indicates that death or severe personal injury may result if proper precautions are not taken.

! CAUTION
indicates that minor personal injury can result if proper precautions are not taken.

NOTICE
indicates that property damage can result if proper precautions are not taken.

If more than one degree of danger is present, the warning notice representing the highest degree of danger will be used. A notice warning of injury to persons with a safety alert symbol may also include a warning relating to property damage.

Qualified Personnel

The product/system described in this documentation may be operated only by **personnel qualified** for the specific task in accordance with the relevant documentation, in particular its warning notices and safety instructions. Qualified personnel are those who, based on their training and experience, are capable of identifying risks and avoiding potential hazards when working with these products/systems.

Proper use of Siemens products

Note the following:

! WARNING
Siemens products may only be used for the applications described in the catalog and in the relevant technical documentation. If products and components from other manufacturers are used, these must be recommended or approved by Siemens. Proper transport, storage, installation, assembly, commissioning, operation and maintenance are required to ensure that the products operate safely and without any problems. The permissible ambient conditions must be complied with. The information in the relevant documentation must be observed.

Trademarks

All names identified by ® are registered trademarks of Siemens AG. The remaining trademarks in this publication may be trademarks whose use by third parties for their own purposes could violate the rights of the owner.

Disclaimer of Liability

We have reviewed the contents of this publication to ensure consistency with the hardware and software described. Since variance cannot be precluded entirely, we cannot guarantee full consistency. However, the information in this publication is reviewed regularly and any necessary corrections are included in subsequent editions.

Table of contents

1	Introduction	5
1.1	Purpose of this documentation	5
1.2	Document history	5
1.3	Device identification	6
1.4	Designated use	11
1.5	Product compatibility	12
1.6	Checking the consignment	12
1.7	Security information	13
1.8	Transportation and storage	14
1.9	Notes on warranty	14
2	Safety notes	15
2.1	Preconditions for use	15
2.1.1	Conformity with European directives	16
2.2	Requirements for special applications	16
2.3	Use in hazardous areas	17
3	Installing/mounting	19
3.1	Basic safety notes	19
3.1.1	Installation location requirements	20
3.1.2	Proper mounting	21
3.2	Sensor installation	22
3.2.1	Determining a location	22
3.2.2	Orientation of the sensor	23
3.2.3	Installation in a drop line	26
3.3	Disassembly	26
4	Connecting	27
4.1	Basic safety notes	27
4.2	Connecting FC330	31
4.2.1	Cable requirements	31
4.2.2	Transmitter power supply and I/Os connection	31
4.2.2.1	Connecting the DSL and the transmitter	31
4.2.2.2	Preparing for the transmitter connections	35
4.2.2.3	Connecting the Current HART, CH1	37
4.2.2.4	Connecting the Modbus (CH1)	39
4.2.2.5	Connecting the Profibus (CH1)	41
4.2.2.6	Connecting channels 2 to 4	42
4.2.2.7	Input/output configuration	44

4.2.2.8	Connecting the power supply - Field mount.....	45
4.2.2.9	Connecting the power supply - Wall mount.....	47
4.2.2.10	Finishing the transmitter connection	48
5	Commissioning	51
5.1	Basic safety notes	51
6	Service and maintenance	55
6.1	Basic safety notes	55
6.2	Cleaning	56
6.3	Maintenance and repair work.....	57
6.4	Replacing the device.....	59
6.5	Return procedure	60
6.6	Disposal	60
7	Technical data	61
7.1	Power	61
7.2	Bus communication.....	61
7.3	Operating conditions	62
7.4	Certificates and approvals.....	63
A	Certificates and support.....	65
A.1	Technical support.....	65
A.2	Certificates	65
	Index.....	67

Introduction

1.1 Purpose of this documentation

These instructions contain all information required to commission and use the device. Read the instructions carefully prior to installation and commissioning. In order to use the device correctly, first review its principle of operation.

The instructions are aimed at persons mechanically installing the device, connecting it electronically, configuring the parameters and commissioning it, as well as service and maintenance engineers.

See also

Certificates (Page 65)

Technical support (Page 65)

1.2 Document history

The following table shows major changes in the documentation compared to the previous edition.

The most important changes in the documentation when compared with the respective previous edition are given in the following table.

Edition	Note
01/2019	Second edition <ul style="list-style-type: none">• Chapter Technical data (Page 61) updated• Overall revision of chapters and contents
06/2018	First edition

1.3 Device identification

Each part of the FC330 Coriolis flowmeter has 3 nameplate types which show the following information:

- product identification
- product specifications
- certificates and approvals

Note

Identification

Identify your device by comparing your ordering data with the information on the product and specification nameplates.

Transmitter identification nameplate example

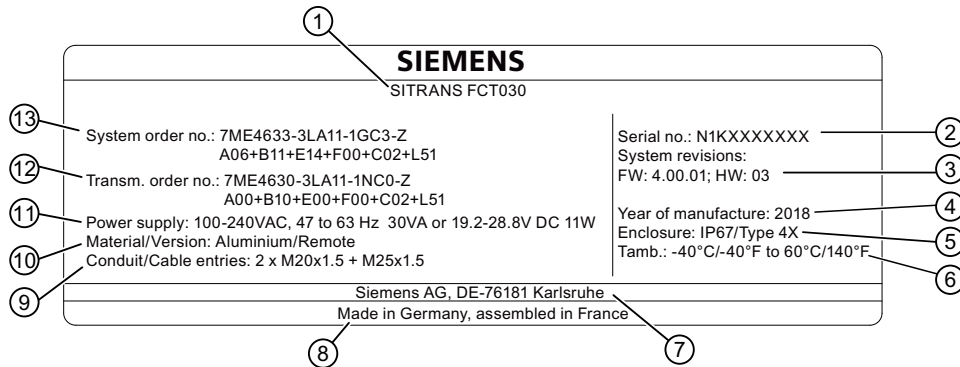

- | | | |
|---|------------------------------|--|
| ① | SITRANS FCT030 ¹⁾ | Product name |
| ② | Serial no. | Serial number |
| ③ | System revisions | System revision numbers firmware (FW) and hardware (HW) |
| ④ | Year of manufacture | Manufacturing year |
| ⑤ | Enclosure | Degree of protection |
| ⑥ | Tamb. | Range of ambient temperature |
| ⑦ | Manufacturer | Manufacturer name and location |
| ⑧ | Country | Manufacturing country |
| ⑨ | Conduit / Cable entries | Type of conduit / cable entries |
| ⑩ | Material / Version | Transmitter housing material and version (compact/remote) |
| ⑪ | Power supply | Power supply |
| ⑫ | Transm. order no. | Device-specific transmitter order number |
| ⑬ | System order no. | Device-specific system order number (transmitter and sensor) |

¹⁾ With compact versions, the transmitter and sensor product identifications are both given as 'SITRANS FC330'.

With remote versions, the transmitter is identified as 'SITRANS FCT030' and the sensor as 'SITRANS FCS300'.

Sensor identification nameplate example

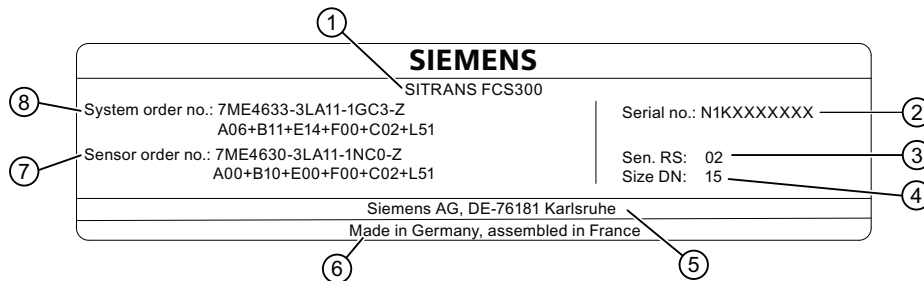

- | | | |
|---|------------------------------|--|
| ① | SITRANS FCS300 ¹⁾ | Product name |
| ② | Serial no. | Serial number |
| ③ | Sen. RS | Mechanical sensor version number |
| ④ | Size DN | Size |
| ⑤ | Manufacturer | Manufacturer name and location |
| ⑥ | Country | Manufacturing country |
| ⑦ | Sensor order no. | Sensor replacement order number |
| ⑧ | System order no. | Flowmeter system order number (transmitter and sensor) |

¹⁾ With compact versions, the transmitter and sensor product identifications are both given as 'SITRANS FC330'.

With remote versions, the transmitter is identified as 'SITRANS FCT030' and the sensor as 'SITRANS FCS300'.

Flowmeter serial number construction

The flowmeter serial number consists of the following:

PPYMDDXXXX

where

PP = Production factory (Siemens Flow Instruments: N1)

Y = Production year (for encryption, see below)

M = Production month (for encryption, see below)

DD = Production day (for encryption, see below)

XXXX = Sequential number

Encryption:

Calendar year (Y)

1950, 1970, 1990, 2010

1951, 1971, 1991, 2011

1952, 1972, 1992, 2012

1953, 1973, 1993, 2013

1954, 1974, 1994, 2014

1955, 1975, 1995, 2015

1956, 1976, 1996, 2016

1957, 1977, 1997, 2017

Code

A

B

C

D

E

F

H (G)

J

1.3 Device identification

1958, 1978, 1998, 2018	K
1959, 1979, 1999, 2019	L
1960, 1980, 2000, 2020	M
1961, 1981, 2001, 2021	N
1962, 1982, 2002, 2022	P
1963, 1983, 2003, 2023	R
1964, 1984, 2004, 2024	S
1965, 1985, 2005, 2025	T
1966, 1986, 2006, 2026	U
1967, 1987, 2007, 2027	V
1968, 1988, 2008, 2028	W
1969, 1989, 2009, 2029	X
Month (M)	Code
January	1
February	2
March	3
April	4
May	5
June	6
July	7
August	8
September	9
October	O
November	N
December	D
Day (DD)	Code
Day 01 to 31	01 to 31 (corresponding to the actual date)

FCT030 transmitter specification nameplate example

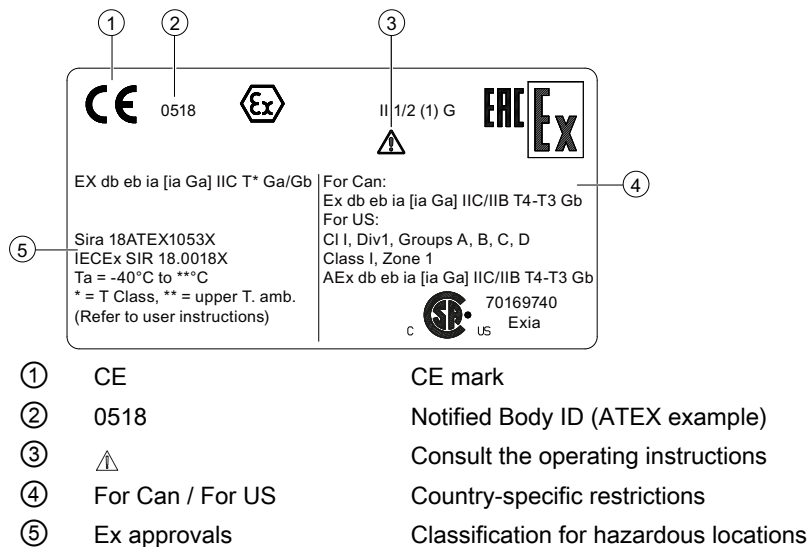
**Note****Approvals and identifications**

Approval certificates and notified body identifications are available for download at www.siemens.com (<http://www.siemens.com/processinstrumentation/certificates>).

FCS300 sensor specification nameplate example

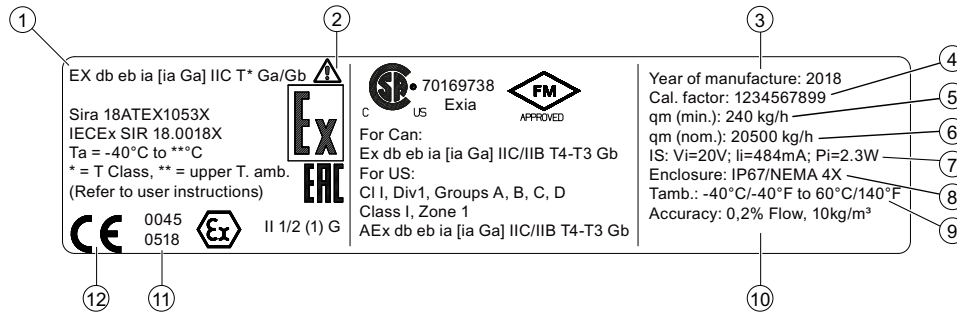

- | | | |
|---|---------------------|---|
| ① | Ex approvals | Classification for hazardous locations |
| ② | ⚠️ | Consult the operating instructions |
| ③ | Year of Manufacture | Manufacturing year
More detailed date of manufacture information is given in the serial number on the identification nameplate |
| ④ | Cal. Factor | Calibration factor |
| ⑤ | qm (min) | Minimum mass flows with water at 20 °C (68 °F) |
| ⑥ | qm (nom) | Nominal mass flows with water at 20 °C (68 °F) |
| ⑦ | IS | Intrinsic Safety + Parameter |
| ⑧ | Enclosure | Degree of protection |
| ⑨ | Tamb. | Range of ambient temperature |
| ⑩ | Accuracy | Mass flow, density calibration accuracy |
| ⑪ | 0518 | Notified Body ID (ATEX example) |
| ⑫ | CE | CE mark |

FCT030 transmitter approval nameplate example

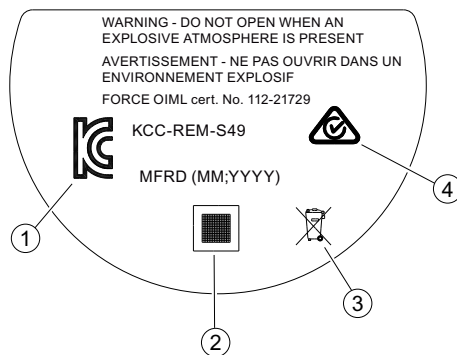

- | | | |
|---|---------|---|
| ① | IC | Conformity with country-specific directives |
| ② | QR code | Product-specific QR code |
| ③ | ♻️ | WEEE symbol |
| ④ | C✓ | Conformity with country-specific directives |

FCS300 sensor approval nameplate example

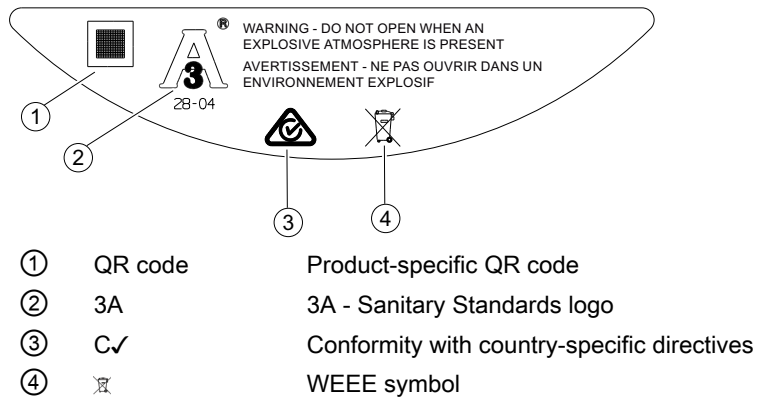

Note

Logos and warnings

Logos and warnings are only shown on the product where applicable. The combination shown in the example above is relevant for a hygienic sensor installed in hazardous area in Canada.

The Australian C-tick mark is mandatory on all products.

QR code

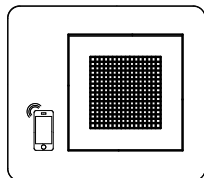

With the use of a smart phone, the QR code provides a direct link to

- the product support portal
- the product and production-specific documentation maintained in the production database.

1.4 Designated use

You can use the Coriolis flowmeter for the following measuring tasks:

- Mass flow
- Volume flow
- Density
- Process temperature

Operate the device according to the specifications in section Technical data (Page 61).

For additional information, refer to the operating instructions for the device.

1.5 Product compatibility

Edition	Remarks	Product compatibility	Compatibility of device integration package	
01/2019	Manual content updated	HW revision 03 Compact FW revision 4.xx.xx-xx Remote FW revision 4.xx.xx-xx	Service channel: SIMATIC V8.2 Service Pack 1 or later	5.00.xx-xx
			Modbus: SIMATIC V8.2 Service Pack 1 or later	5.00.xx-xx
			HART: SIMATIC V8.2 Service Pack 1 or later	5.00.xx-xx
			HART: SITRANS DTM V4.1	5.00.xx-xx
			HART: AMS Device manager V12	5.00.xx-xx
			PROFIBUS: SIMATIC V8.2 Service Pack 1 or later	1.00.xx-xx
			PROFIBUS: AMS Device manager V12	1.00.xx-xx
			PROFIBUS : SITRANS DTM V4.1	1.00.xx-xx
06/2018	New hardware New sensor sizes	HW revision 03 Compact FW revision 4.xx.xx-xx Remote FW revision 4.xx.xx-xx	Service channel: SIMATIC V8.2 Service Pack 1 or later	5.00.xx-xx
			Modbus: SIMATIC V8.2 Service Pack 1 or later	5.00.xx-xx
			HART: SIMATIC V8.2 Service Pack 1 or later	5.00.xx-xx
			HART: SITRANS DTM V4.1	5.00.xx-xx
			HART: AMS Device manager V12	5.00.xx-xx
			PROFIBUS: SIMATIC V8.2 Service Pack 1 or later	1.00.xx-xx
			PROFIBUS: AMS Device manager V12	1.00.xx-xx
			PROFIBUS : SITRANS DTM V4.1	1.00.xx-xx

NOTICE

Use in a domestic environment

This Class A Group 1 equipment is intended for use in industrial areas.
In a domestic environment this device may cause radio interference.

1.6 Checking the consignment

1. Check the packaging and the delivered items for visible damages.
2. Report any claims for damages immediately to the shipping company.

3. Retain damaged parts for clarification.
4. Check the scope of delivery by comparing your order to the shipping documents for correctness and completeness.

 WARNING
Using a damaged or incomplete device
Risk of explosion in hazardous areas.
<ul style="list-style-type: none">• Do not use damaged or incomplete devices.

1.7 Security information

Siemens provides products and solutions with industrial security functions that support the secure operation of plants, systems, machines and networks.

In order to protect plants, systems, machines and networks against cyber threats, it is necessary to implement – and continuously maintain – a holistic, state-of-the-art industrial security concept. Siemens' products and solutions constitute one element of such a concept.

Customers are responsible for preventing unauthorized access to their plants, systems, machines and networks. Such systems, machines and components should only be connected to an enterprise network or the internet if and to the extent such a connection is necessary and only when appropriate security measures (e.g. firewalls and/or network segmentation) are in place.

For additional information on industrial security measures that may be implemented, please visit <https://www.siemens.com/industrialsecurity>.

Siemens' products and solutions undergo continuous development to make them more secure. Siemens strongly recommends that product updates are applied as soon as they are available and that the latest product versions are used. Use of product versions that are no longer supported, and failure to apply the latest updates may increase customer's exposure to cyber threats.

To stay informed about product updates, subscribe to the Siemens Industrial Security RSS Feed under <https://www.siemens.com/industrialsecurity>.

1.8 Transportation and storage

To guarantee sufficient protection during transport and storage, observe the following:

- Keep the original packaging for subsequent transportation.
- Devices/replacement parts should be returned in their original packaging.
- If the original packaging is no longer available, ensure that all shipments are properly packaged to provide sufficient protection during transport. Siemens cannot assume liability for any costs associated with transportation damages.

NOTICE
Insufficient protection during storage
The packaging only provides limited protection against moisture and infiltration.
<ul style="list-style-type: none">• Provide additional packaging as necessary.

Special conditions for storage and transportation of the device are listed in Technical data (Page 61).

1.9 Notes on warranty

The contents of this manual shall not become part of or modify any prior or existing agreement, commitment or legal relationship. The sales contract contains all obligations on the part of Siemens as well as the complete and solely applicable warranty conditions. Any statements regarding device versions described in the manual do not create new warranties or modify the existing warranty.

The content reflects the technical status at the time of publishing. Siemens reserves the right to make technical changes in the course of further development.

Safety notes

2.1 Preconditions for use

This device left the factory in good working condition. In order to maintain this status and to ensure safe operation of the device, observe these instructions and all the specifications relevant to safety.

Observe the information and symbols on the device. Do not remove any information or symbols from the device. Always keep the information and symbols in a completely legible state.

Symbol	Explanation
	Consult operating instructions

Observe the safety rules, provisions and laws applicable in your country during connection, assembly and operation. These include, for example:

- National Electrical Code (NEC - NFPA 70) (USA)
- Canadian Electrical Code (CEC) (Canada)

Further provisions for hazardous area applications are for example:

- IEC 60079-14 (international)
- EN 60079-14 (EU)

Observe the test certification, provisions and laws applicable in your country during connection, assembly and operation. These include, for example:

- National Electrical Code (NEC - NFPA 70) (USA)
- Canadian Electrical Code (CEC) (Canada)

Further provisions for hazardous area applications are for example:

- IEC 60079-14 (international)
- EN 60079-14 (EU)

- For Korea only:

이 기기는 업무용(A 급) 전자파 적합기기로서 판매자 또는 사용자는 이 점을 주의하시기 바라며 가정 외의

지역에서 사용하는 것을 목적으로 합니다

2.1.1 Conformity with European directives

The CE marking on the device symbolizes the conformity with the following European directives:

Electromagnetic compatibility EMC 2014/30/EU	Directive of the European Parliament and of the Council on the harmonisation of the laws of the Member States relating to electromagnetic compatibility
Low voltage directive LVD 2014/35/EU	Directive of the European Parliament and of the Council on the harmonisation of the laws of the Member States relating to the making available on the market of electrical equipment designed for use within certain voltage limits
Atmosphère explosible ATEX 2014/34/EU	Directive of the European Parliament and the Council on the harmonisation of the laws of the Member States relating to equipment and protective systems intended for use in potentially explosive atmospheres
Pressure equipment directive PED 2014/68/EU	Directive of the European Parliament and of the Council on the approximation of the laws of the Member States concerning pressure equipment
2011/65/EU RoHS	Directive of the European Parliament and the Council on the restriction of the use of certain hazardous substances in electrical and electronic equipment

The applicable directives can be found in the EC conformity declaration of the specific device.

 WARNING
Improper device modifications Risk to personnel, system and environment can result from modifications to the device, particularly in hazardous areas. <ul style="list-style-type: none">• Only carry out modifications that are described in the instructions for the device. Failure to observe this requirement cancels the manufacturer's warranty and the product approvals.

2.2 Requirements for special applications

Due to the large number of possible applications, each detail of the described device versions for each possible scenario during commissioning, operation, maintenance or operation in systems cannot be considered in the instructions. If you need additional information not covered by these instructions, contact your local Siemens office or company representative.

Note

Operation under special ambient conditions

We highly recommend that you contact your Siemens representative or our application department before you operate the device under special ambient conditions as can be encountered in nuclear power plants or when the device is used for research and development purposes.

2.3 Use in hazardous areas

Special conditions for safe use

In general, it is required that:

- EN/IEC 60079-14 is considered for installation in hazardous areas.
- Appropriate cable connectors are used.
- Sensor is connected to the potential equalization throughout the hazardous area.
- The device is not opened when energized and when an explosive gas or dust atmosphere may be present.

Further information and instructions including approval-specific special conditions for safe use in Ex applications can be found in the certificates on the documentation disk and at the product web page (www.siemens.com/FC330).

 WARNING
Substitution of components
Substitution of components may impair Intrinsic Safety.

 WARNING
Laying of cables
Risk of explosion in hazardous areas.
Cable for use in hazardous areas must satisfy the requirements for having a proof voltage of at least 500 V AC applied between the conductor/ground, conductor/shield and shield/ground.
Connect the devices that are operated in hazardous areas as per the stipulations applicable in the country of operation.

 WARNING
Field wiring installation
Ensure that the national requirements of the country in which the devices are installed are met.

Qualified personnel for hazardous area applications

Persons who install, connect, commission, operate, and service the device in a hazardous area must have the following specific qualifications:

- They are authorized, trained or instructed in operating and maintaining devices and systems according to the safety regulations for electrical circuits, high pressures, aggressive, and hazardous media.
- They are authorized, trained, or instructed in carrying out work on electrical circuits for hazardous systems.
- They are trained or instructed in maintenance and use of appropriate safety equipment according to the pertinent safety regulations.

 WARNING
Use in hazardous area
Risk of explosion.
<ul style="list-style-type: none">• Only use equipment that is approved for use in the intended hazardous area and labeled accordingly.• Do not use devices that have been operated outside the conditions specified for hazardous areas. If you have used the device outside the conditions for hazardous areas, make all Ex markings unrecognizable on the nameplate.

See also

Technical data (Page 61)

 WARNING
Loss of safety of device with type of protection "Intrinsic safety Ex i"
If the device or its components have already been operated in non-intrinsically safe circuits or the electrical specifications have not been observed, the safety of the device is no longer ensured for use in hazardous areas. There is a risk of explosion.
<ul style="list-style-type: none">• Connect the device with type of protection "Intrinsic safety" solely to an intrinsically safe circuit.• Observe the specifications for the electrical data on the certificate and/or in Technical data (Page 61).

Installing/mounting

3.1 Basic safety notes

 WARNING**Wetted parts unsuitable for the process media**

Risk of injury or damage to device.

Hot, toxic and corrosive media could be released if the wetted parts are unsuitable for the process medium.

- Ensure that the material of the device parts wetted by the process medium is suitable for the medium. Refer to the information in Technical data (Page 61).

Note**Material compatibility**

Siemens can provide you with support concerning selection of sensor components wetted by process media. However, you are responsible for the selection of components. Siemens accepts no liability for faults or failures resulting from incompatible materials.

 WARNING**Unsuitable connecting parts**

Risk of injury or poisoning.

In case of improper mounting, hot, toxic, and corrosive process media could be released at the connections.

- Ensure that connecting parts (such as flange gaskets and bolts) are suitable for connection and process media.

See also

Technical data (Page 61)

 WARNING
Exceeded maximum permissible operating pressure
Risk of injury or poisoning.
The maximum permissible operating pressure depends on the device version, pressure limit and temperature rating. The device can be damaged if the operating pressure is exceeded. Hot, toxic and corrosive process media could be released.
Ensure that maximum permissible operating pressure of the device is not exceeded. Refer to the information on the nameplate and/or in Technical data (Page 61).

 CAUTION
Hot surfaces resulting from hot process media
Risk of burns resulting from surface temperatures above 65 °C (149 °F).
<ul style="list-style-type: none">• Take appropriate protective measures, for example contact protection.• Make sure that protective measures do not cause the maximum permissible ambient temperature to be exceeded. Refer to the information in Technical data (Page 61).

 CAUTION
External stresses and loads
Damage to device by severe external stresses and loads (e.g. thermal expansion or pipe tension). Process media can be released.
<ul style="list-style-type: none">• Prevent severe external stresses and loads from acting on the device.

3.1.1 Installation location requirements

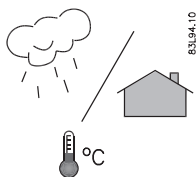

SITRANS F flowmeters with minimum IP67/NEMA 4X enclosure rating are suitable for indoor and outdoor installations.

Process pressure and medium temperature

If applicable, make sure that specifications for rated process pressure (PS) and medium temperature (TS) plus ambient temperature that are indicated on the device nameplate / label will not be exceeded.

Aggressive atmospheres

Ensure that the device is suitable for the application and that it is installed where there is no risk of penetration of aggressive vapors.

Direct sunlight

Prevent the device from overheating or materials becoming brittle due to UV exposure by protecting it from direct sunlight. Make sure that the maximum permissible ambient temperature is not exceeded. Refer to the information in Use in hazardous areas (Page 17).

 WARNING
--

Equipment used in hazardous areas
--

Risk of explosion in hazardous areas.

Special requirements apply to the location and installation of the device. See Use in hazardous areas (Page 17).
--

 WARNING
--

Strong vibrations

Risk of explosion in hazardous areas.

- | |
|---|
| <ul style="list-style-type: none">• In plants with strong vibrations, mount the transmitter in a low vibration environment. |
|---|

See also

Operating conditions (Page 62)

NOTICE

Strong vibrations

Damage to device.

- | |
|--|
| <ul style="list-style-type: none">• In installations with strong vibrations, mount the transmitter in a low vibration environment. |
|--|

3.1.2 Proper mounting

 WARNING
--

Incorrect mounting at Zone 0

Risk of explosion in hazardous areas.

- | |
|--|
| <ul style="list-style-type: none">• Ensure sufficient tightness at the process connection.• Observe the standard IEC/EN 60079-14. |
|--|

 WARNING
Loss of type of protection Risk of explosion. Damage to device if the enclosure is open or not properly closed. The type of protection specified on the nameplate or in Technical data (Page 61) is no longer guaranteed. <ul style="list-style-type: none">• Make sure that the device is securely closed.

NOTICE
Incorrect mounting The device can be damaged, destroyed, or its functionality impaired through improper mounting. <ul style="list-style-type: none">• Before installing ensure there is no visible damage to the device.• Make sure that process connectors are clean, and suitable gaskets and glands are used.• Mount the device using suitable tools. Refer to the information in Technical data (Page 61).

3.2 Sensor installation

3.2.1 Determining a location

 CAUTION
Electromagnetic fields Do not install the flowmeter in the vicinity of strong electromagnetic fields, for example near motors, variable frequency drives, transformers etc.

Upstream / downstream

- No pipe run requirements, that is straight inlet/outlet sections, are necessary.
- Avoid long drop lines downstream from the sensor to prevent process media separation causing air / vapor bubbles in the tube (min. back pressure: 0.2 bar).
- Avoid installing the flowmeter immediately upstream of a free discharge in a drop line.

Location in the system

The optimum location in the system depends on the application:

- Liquid applications
Gas or vapor bubbles in the fluid may result in erroneous measurements, particularly in the density measurement.
 - Do not install the flowmeter at the highest point in the system, where bubbles will be trapped.
 - Install the flowmeter in low pipeline sections, at the bottom of a U-section in the pipeline.

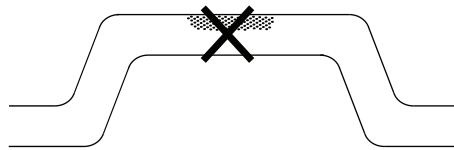

Figure 3-1 Liquid applications, wrong location with trapped air/gas

- Gas applications
Vapor condensation or oil traces in the gas may result in erroneous measurements.
 - Do not install the flowmeter at the lowest point of the system.
 - Install a filter.

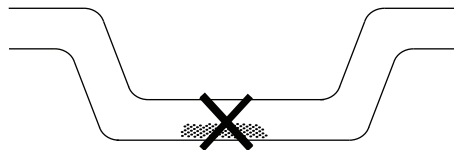

Figure 3-2 Gas applications, wrong location with trapped oil

3.2.2 Orientation of the sensor

Flow direction

The calibrated flow direction is indicated by the arrow on the sensor. Flow in this direction will be indicated as positive by default. The sensitivity and the accuracy of the sensor do not change with reverse flow.

The indicated flow direction (positive/negative) is configurable.

CAUTION

Accurate measurement

The sensor must always be completely filled with process media in order to measure accurately.

NOTICE
Orienting the sensor
To avoid water or moist ingress, transmitters should be oriented with cable entrances aiming downwards.

Orienting the sensor

The sensor operates in any orientation. The optimal orientation depends on the process fluid and the process conditions. Siemens recommends orienting the sensor in one of the following ways:

1. Vertical installation with an upwards flow (self-draining)

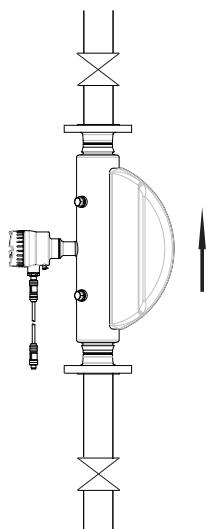

Figure 3-3 Vertical orientation, upwards flow

2. Horizontal installation, tubes down (recommended for liquid applications)

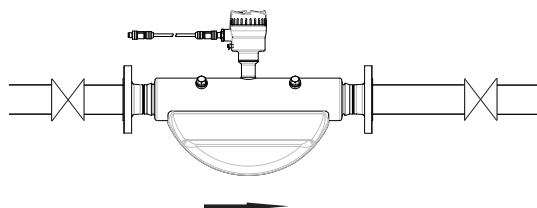

Figure 3-4 Horizontal orientation, tubes down

3. Horizontal installation, tubes up (recommended for gas applications)

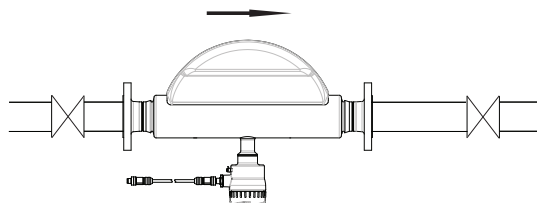

Figure 3-5 Horizontal orientation; tubes up

Note

Hygienic applications

In EHEDG certified applications the flowmeter must be installed vertically as shown in 1 above. *(EHEDG certificate in preparation)*

3.2.3 Installation in a drop line

Installation in a drop line is only recommended if a pipeline reduction or orifice with a smaller cross-section can be installed to create back-pressure and prevent the sensor from being partially drained while measuring.

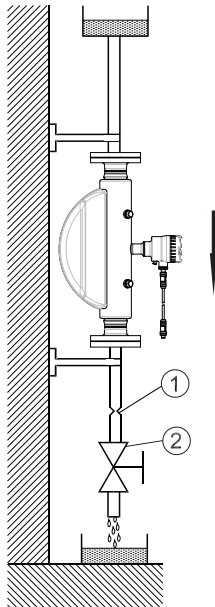

- ① Back pressure orifice
- ② On / off valve

Figure 3-6 Installation in drop line

3.3 Disassembly

<p>⚠ WARNING</p> <p>Incorrect disassembly</p> <p>The following risks may result from incorrect disassembly:</p> <ul style="list-style-type: none">- Injury through electric shock- Risk through emerging media when connected to the process- Risk of explosion in hazardous area <p>In order to disassemble correctly, observe the following:</p> <ul style="list-style-type: none">• Before starting work, make sure that you have switched off all physical variables such as pressure, temperature, electricity etc. or that they have a harmless value.• If the device contains hazardous media, it must be emptied prior to disassembly. Make sure that no environmentally hazardous media are released.• Secure the remaining connections so that no damage can result if the process is started unintentionally.
--

Connecting

4.1 Basic safety notes

 **WARNING**

Unsuitable cables, cable glands and/or plugs

Risk of explosion in hazardous areas.

- Use only cable glands/plugs that comply with the requirements for the relevant type of protection.
- Tighten the cable glands in accordance with the torques specified in Technical data (Page 61).
- Close unused cable inlets for the electrical connections.
- When replacing cable glands, only use cable glands of the same type.
- After installation, check that the cables are seated firmly.

 **WARNING**

Incorrect conduit system

Risk of explosion in hazardous areas as result of open cable inlet or incorrect conduit system.

- In the case of a conduit system, mount a spark barrier at a defined distance from the device input. Observe national regulations and the requirements stated in the relevant approvals.

See also

Technical data (Page 61)

 **WARNING**

Hazardous contact voltage

Risk of electric shock in case of incorrect connection.

- For the electrical connection specifications, refer to the information in Technical data (Page 61).
- At the mounting location of the device observe the applicable directives and laws for installation of electrical power installations with rated voltages below 1000 V.

 WARNING
Missing PE/ground connection
Risk of electric shock.
Depending on the device version, connect the power supply as follows:
<ul style="list-style-type: none">• Power plug: Ensure that the used socket has a PE/ground conductor connection. Check that the PE/ground conductor connection of the socket and power plug match each other.• Connecting terminals: Connect the terminals according to the terminal connection diagram. First connect the PE/ground conductor.

 WARNING
Improper power supply
Risk of explosion in hazardous areas as result of incorrect power supply.
<ul style="list-style-type: none">• Connect the device in accordance with the specified power supply and signal circuits. The relevant specifications can be found in the certificates, in Technical data (Page 61) or on the nameplate.

 WARNING
Lack of equipotential bonding
Risk of explosion through compensating currents or ignition currents through lack of equipotential bonding.
<ul style="list-style-type: none">• Ensure that the device is potentially equalized.
Exception: It may be permissible to omit connection of the equipotential bonding for devices with type of protection "Intrinsic safety Ex i".

 WARNING
Unprotected cable ends
Risk of explosion through unprotected cable ends in hazardous areas.
<ul style="list-style-type: none">• Protect unused cable ends in accordance with IEC/EN 60079-14.

 WARNING
Improper laying of shielded cables
Risk of explosion through compensating currents between hazardous area and the non-hazardous area.
<ul style="list-style-type: none">• Shielded cables that cross into hazardous areas should be grounded only at one end.• If grounding is required at both ends, use an equipotential bonding conductor.

 **WARNING****Uncovered non-intrinsically safe circuits**

Risk of explosion in hazardous areas or electric shock when working on non-intrinsically safe circuits.

If intrinsically safe and non-intrinsically safe circuits are operated in an enclosure with the type of protection "Increased safety Ex e", the connections of the non-intrinsically safe circuits must be additionally covered.

- Ensure that the cover of the non-intrinsically safe circuits complies with degree of protection IP30 or higher according to IEC/EN 60529.
- Separate connections of the non-intrinsically safe circuits in accordance with IEC/EN 60079-14.

 **WARNING****Insufficient isolation of intrinsically safe and non-intrinsically safe circuits**

Risk of explosion in hazardous areas.

- When connecting intrinsically safe and non-intrinsically safe circuits ensure that isolation is carried out properly in accordance with local regulations for example IEC 60079-14.
- Ensure that you observe the device approvals applicable in your country.

 **WARNING****Connecting device in energized state**

Risk of explosion in hazardous areas.

- Connect devices in hazardous areas only in a de-energized state.

Exceptions:

- Devices having the type of protection "Intrinsic safety Ex i" may also be connected in energized state in hazardous areas.
- Exceptions for type of protection "Increased safety ec" (Zone 2) are regulated in the relevant certificate.

 **WARNING****Incorrect selection of type of protection**

Risk of explosion in areas subject to explosion hazard.

This device is approved for several types of protection.

1. Decide in favor of one type of protection.
2. Connect the device in accordance with the selected type of protection.
3. In order to avoid incorrect use at a later point, make the types of protection that are not used permanently unrecognizable on the nameplate.

NOTICE

Ambient temperature too high

Damage to cable sheath.

- At an ambient temperature $\geq 60\text{ }^{\circ}\text{C}$ ($140\text{ }^{\circ}\text{F}$), use heat-resistant cables suitable for an ambient temperature at least $20\text{ }^{\circ}\text{C}$ ($36\text{ }^{\circ}\text{F}$) higher.

NOTICE

Condensation in the device

Damage to device through formation of condensation if the temperature difference between transportation or storage and the mounting location exceeds $20\text{ }^{\circ}\text{C}$ ($36\text{ }^{\circ}\text{F}$).

- Before taking the device into operation, let the device adapt for several hours in the new environment.

Note

Electromagnetic compatibility (EMC)

You can use this device in industrial environments, households and small businesses.

For metal housings there is an increased electromagnetic compatibility compared to high-frequency radiation. This protection can be increased by grounding the housing, see Connecting (Page 27).

Note

Improvement of interference immunity

- Lay signal cables separate from cables with voltages $> 60\text{ V}$.
 - Use cables with twisted wires.
 - Keep device and cables at a distance from strong electromagnetic fields.
 - Take account of the conditions for communication specified in the Technical data (Page 61).
 - Use shielded cables to guarantee the full specification according to HART/PA/FF/Modbus/EIA-485/Profibus DP.
-

4.2 Connecting FC330

4.2.1 Cable requirements

Cable specifications

- When installing sensor cable, use cable with at least same degree of protection as the sensors. It is recommended to use cables supplied by Siemens:
 - blue cables for installation of intrinsically safe circuits in hazardous areas
 - gray cables for installation of non-intrinsically safe circuitsFurther information on Siemens-supplied cables, see Technical data (Page 61).
- The wire length inside the connection compartment, from the cable gland to the terminals, must be kept as short as possible. Wire loops in the terminal compartment must be avoided.
- To guarantee the degree of ingress protection, ensure that both ends of the cables are given equivalent protection from ingress of moisture.

 WARNING
Cable requirements
Cables must be suitable for the temperature (at least 70 °C) and be flammability-rated to at least V-2.

Note**Output cables**

If long cables are used in noisy environments, it is recommended to use shielded cables.

4.2.2 Transmitter power supply and I/Os connection

4.2.2.1 Connecting the DSL and the transmitter

The following only applies to remote configurations.

Wiring DSL (sensor) and transmitter (M12)

The DSL is provided with a preformed cable terminated with M12 style stainless steel weather-proof plugs.

The cable screen is physically and electrically terminated within the body of the plug.

Take care when handling the cable and passing it through cable ducting that the plug is not subjected to excessive tension (pulling) as the internal connections may be disengaged.

Note

Never pull the cable by the plug - only by the cable itself.

1. Connect DSL using the supplied 4-wire cable with M12 connectors.

Note

Grounding

The DSL cable screen is mechanically connected to the grounding terminal (PE), only when the M12 plug is correctly tightened.

Wiring sensor and transmitter (sensor terminal compartment)

A: Prepare the cable by stripping it at both ends.

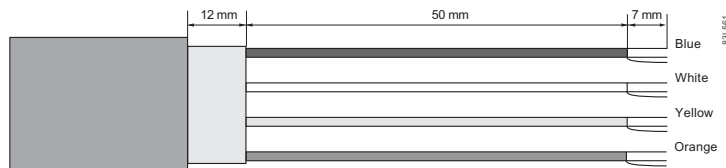

Figure 4-1 Cable end

B: Connecting sensor terminal compartment

1. Remove lock screw and remove lid.
2. Remove one of the blind plugs and fit cable gland.
3. Remove cap and ferrule from cable gland and slide onto cable.
4. Push cable through open gland; anchor cable with clamp bar. Ensure that the clamp does not earth the screen. Apply heat-shrink sleeve to make sure the screen is only earthed at the sensor end.

5. Connect wires to terminals according to list below.

Terminal number	Description	Wire color (Siemens)
1	20 V	Orange
2	0 V	Yellow
3	RS-485 / B	White
4	RS-485 / A	Blue



6. Assemble and tighten cable gland
7. Remove O-ring from lid.
8. Reinstall lid and screw in until mechanical stop. Wind back lid by one turn.
9. Mount O-ring by pulling it over the lid and tighten lid until you feel friction from the O-ring on both sides. Wind lid further by one quarter of a turn to seal on the O-ring.
10. Reinstall and tighten lid lock screw

Connecting sensor DSL

1. Remove lock screw and remove DSL lid.
2. Undo the flexible strap.
3. Disconnect sensor connection from DSL cassette.
4. Loosen mounting screw using a TX10 Torx driver and remove DSL cassette from housing.
5. Remove cap and ferrule from cable gland and slide onto cable.
6. Push cable through open gland; anchor cable screen and wires with clamp bar.
7. Remove terminal block from DSL cassette.

8. Connect wires to terminals according to list below.

Terminal number	Description	Wire color (Siemens cable)
1	20 V	Orange
2	0 V	Yellow
3	RS-485 / B	White
4	RS-485 / A	Blue

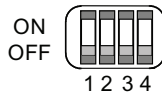
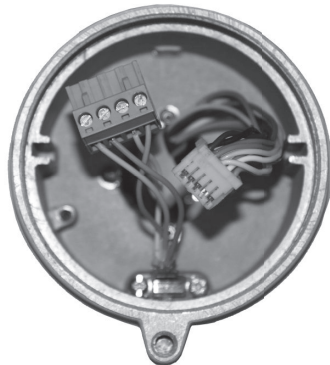

- 9. Ensure the DIP switches are all set to OFF.
- 10. Reinstall DSL cassette including mounting screw.
- 11. Connect sensor connection and sensor cable plugs.
- 12. Restore flexible strap around all wires.

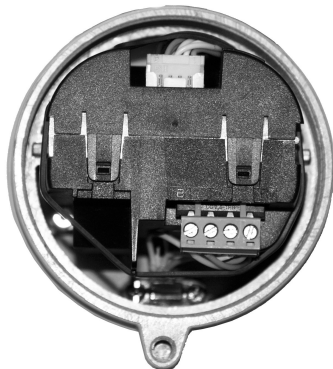

- 13. Assemble and tighten cable gland.
- 14. Remove O-ring from DSL lid.
- 15. Reinstall lid and screw in until mechanical stop. Wind back lid by one turn.
- 16. Mount O-ring by pulling it over the DSL lid and tighten lid until you feel friction from the O-ring on both sides. Wind lid further by one quarter of a turn to seal on the O-ring.
- 17. Reinstall and tighten lid lock screw.
- 18. Close and secure DSL lid including lock screw. Turn the lid until you can feel the friction of the O-ring. From this point turn the lid ¼ turn to be tight.

4.2.2.2 Preparing for the transmitter connections

⚠ WARNING**Access to terminal compartment**

As long as the device is energized, the lid of the housing on the sensor connection area may only be opened by qualified personnel.

Before removing the terminal cover, the auxiliary power must be switched off from all poles.

Following installation, the terminal cover must be screwed back on again.

1. Remove blind plugs where required and mount cable glands.

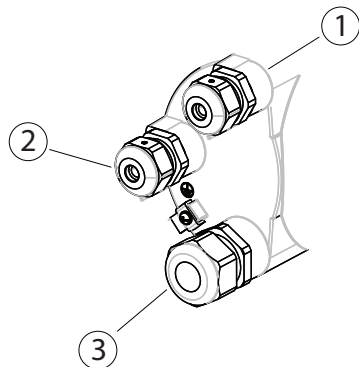

- ① Input/output connection (channels 2 to 4)
- ② Power supply connection
- ③ Current output/communication outputs (channel 1)

2. Remove lid lock screw for terminal connections lid.
3. Remove lid for terminal connections.

A label showing the configuration is placed at the back of the terminal connections lid.

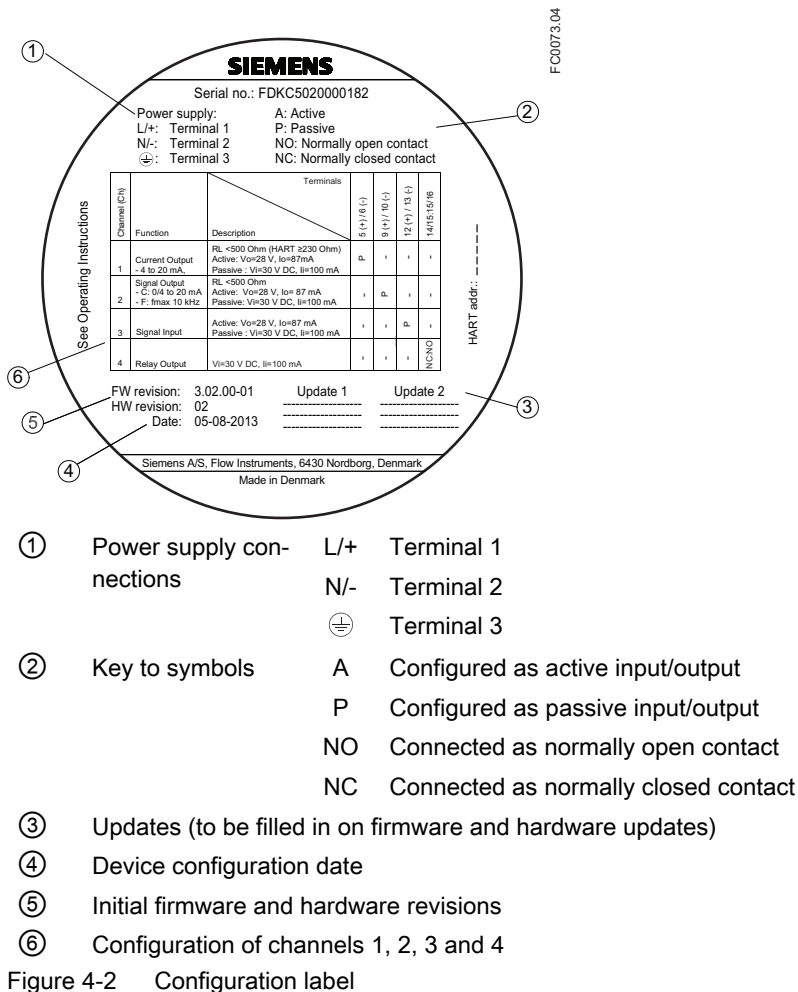
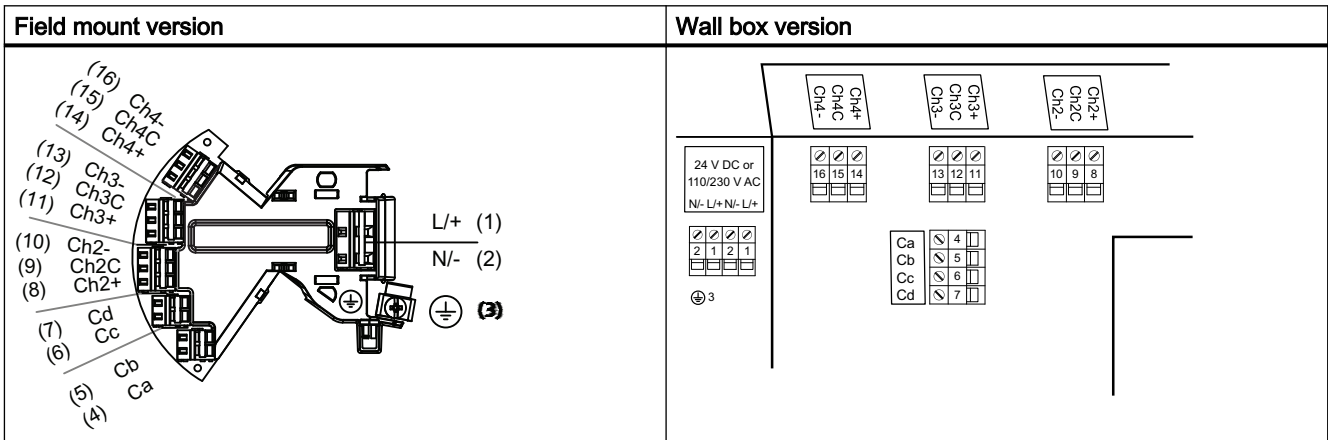

Figure 4-2 Configuration label

Terminal layout



For configuration of the inputs/outputs, see table in section Connecting channels 2 to 4 (Page 42).

The following table shows:

- Which cable with which terminal
- Hardware and software configuration of the channels

HW configuration	SW configuration	Terminals																		
		Power Supply			Channel 1				Channel 2			Channel 3			Channel 4					
		1	2	3	4	5	6	7	8	9	10	11	12	13	14	15	16			
Power Supply		L/+	N/-																	
Channel 1 HART	Current output HART				+ Active	Common -														
					Common + - Passive															
Channel 1 Modbus					In - A	In - B														
							Out - A	Out - B												
Channel 1 Profibus					In - A	In - B														
							Out - A	Out - B												
Channel 2 Output	Current, Frequency, Pulse and Status								+ Active	Common -										
									Common + - Passive											
Channels 3 and 4 Input/output	Outputs: Current, Frequency, Pulse and status Inputs: Digital											+ Active	Common -			+ Active	Common -			
												Common + - Passive				Common + - Passive				
Channels 3 and 4 Relay	Status output											NC			NC					
												NO			NO					

Figure 4-3 Termination/configuration overview

4.2.2.3 Connecting the Current HART, CH1

Note

4 to 20 mA output

It is not required to use shielded cables for the pure 4 to 20 mA current output.

Note

HART communication

It is recommended by the FieldComm Group (FCG) to use shielded cables for the HART communication.

Note

Passive channels only

Channel 1 power supply must be separated from that for channels 2 to 4.

Signal return (or common) can be joined.

1. Remove cap and ferrule from cable gland and slide onto cable.
2. Push cable through open gland and cable path.
3. Restore ferrule and tighten cap to lightly hold cable in place.

4. Signal cable screen is folded back over outer sheath and grounded beneath cable clamp.
 - **Field mount transmitter:** Connect wires to terminals using wiring tool.

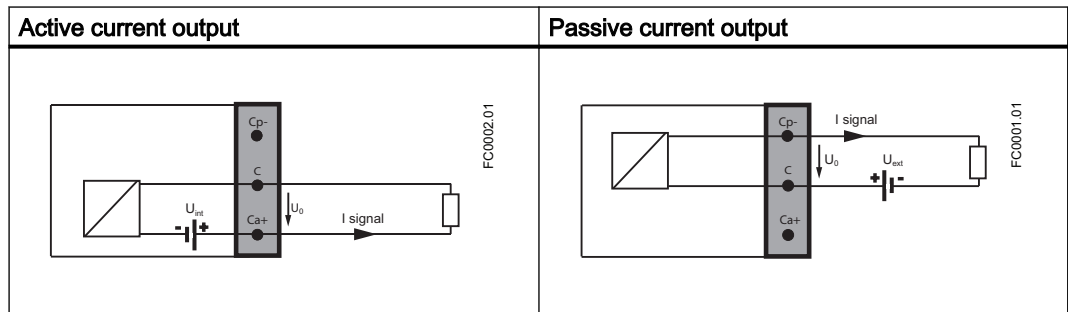
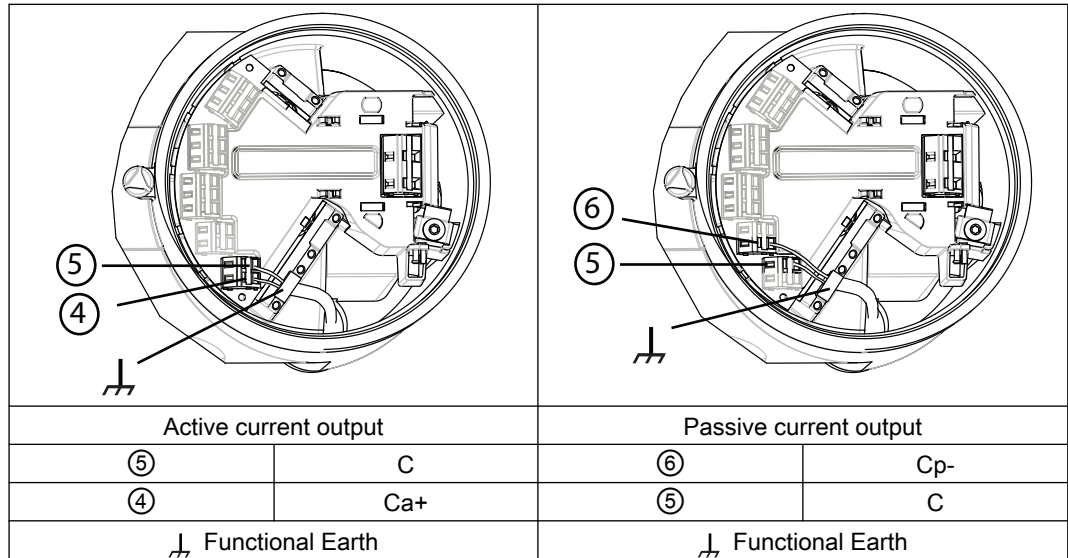

- **Wall mount transmitter:** Connect wires to terminals using wiring tool.

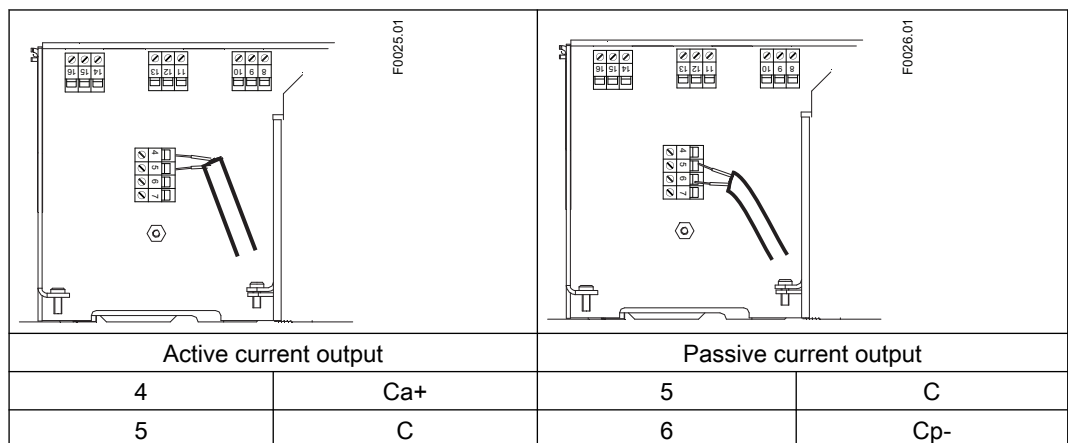

5. Tighten cable gland.

Note

For Ex versions active or passive current output is preselected at ordering and cannot be changed.

Non-Ex versions can be connected as either active or passive.

Note**Load**

Signal output: < 500 Ω at 14 to 24 VDC (active), 14 to 30 VDC (passive)

Relay output: 30 VAC/VDC, 100 mA

Passive signal input: 15 to 30 VDC, 2 to 15 mA

4.2.2.4 Connecting the Modbus (CH1)

1. Remove cap and ferrule from cable gland and slide onto cable.
2. Push cable through open gland and cable path.
3. Restore ferrule and tighten cap to lightly hold cable in place.

4. Signal cable screen is folded back over outer sheath and grounded beneath cable clamp.
 - **Field mount transmitter:** Connect wires to terminals using wiring tool.

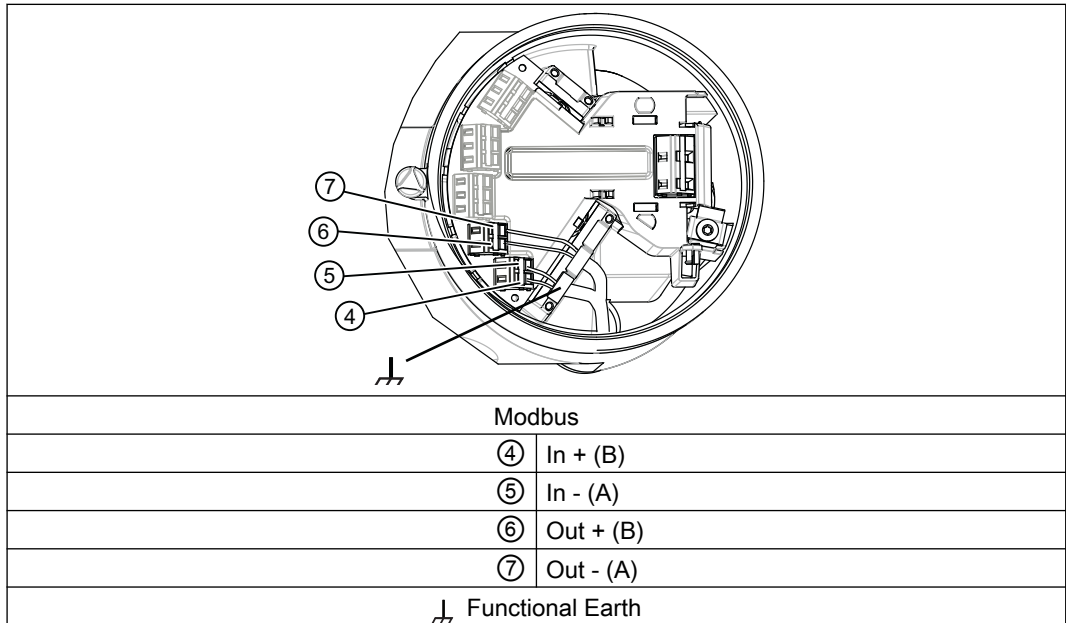

- **Wall mount transmitter:** Connect wires to terminals using wiring tool.

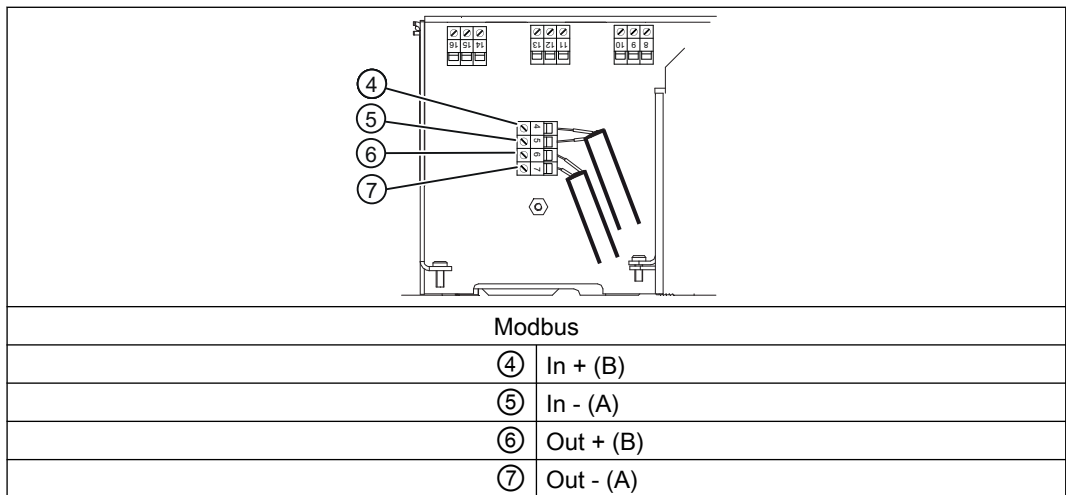

5. Tighten cable gland.

4.2.2.5 Connecting the Profibus (CH1)

 WARNING**Passive channels only**

Channel 1 power supply must be separated from that for channels 2 to 4.

Signal return (or common) can be joined.

1. Remove cap and ferrule from cable gland and slide onto cable.
2. Push cable through open gland and cable path.
3. Restore ferrule and tighten cap to lightly hold cable in place.
4. Signal cable screen is folded back over outer sheath and grounded beneath cable clamp.

5. Connect wires to terminals using wiring tool.

– Field mount transmitter:

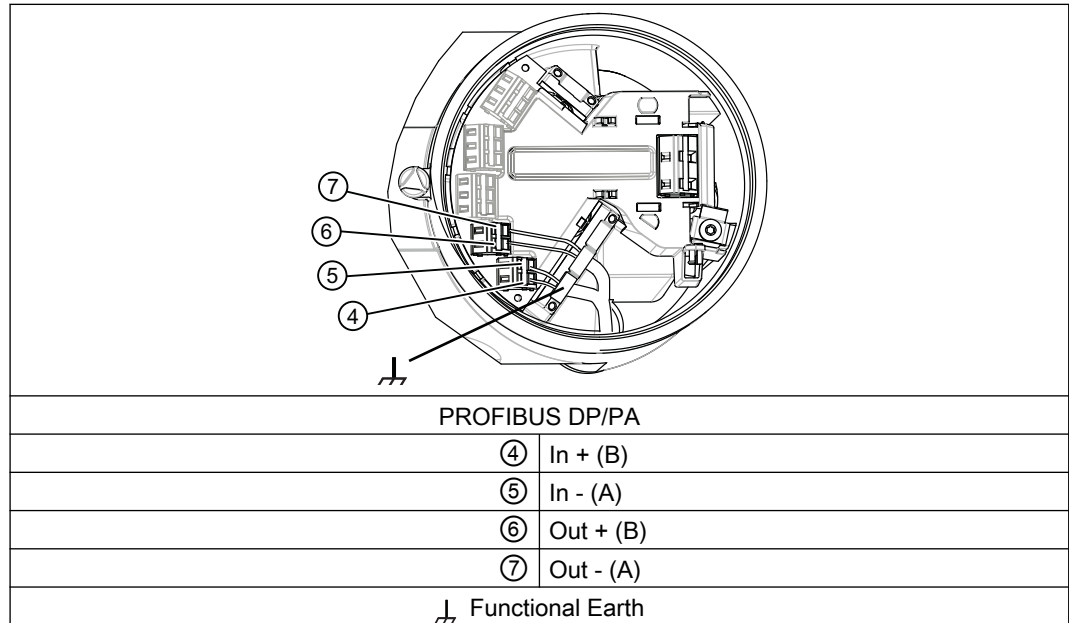

– Wall mount transmitter:

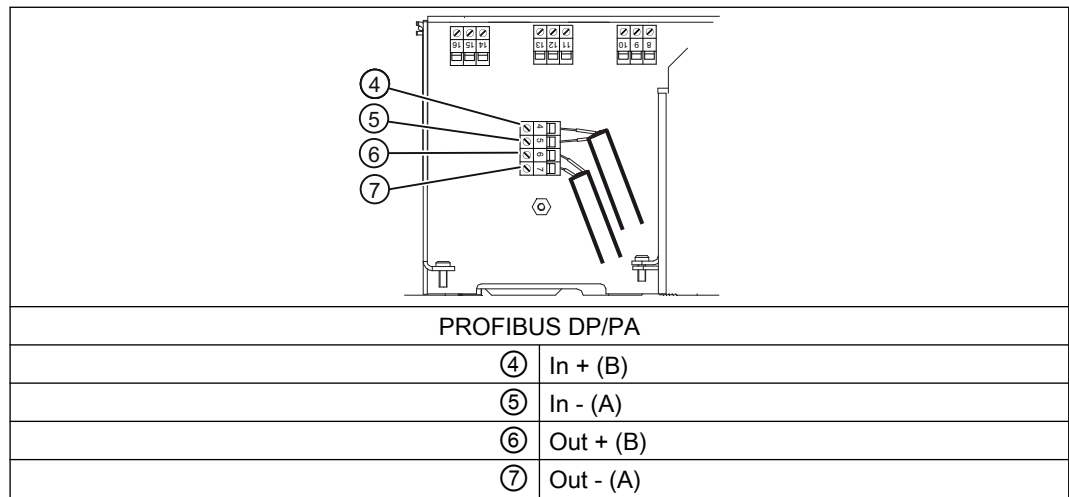

6. Tighten cable gland.

4.2.2.6 Connecting channels 2 to 4

Channel 2 is for output only and channels 3 to 4 can be connected as either inputs/outputs or relays, see Input/output configuration (Page 44).

Connect wires

1. Remove cap and ferrule from cable gland and slide onto cable.
Wall mount enclosure: Remove blind plug and fit cable gland.
2. Push cable through open gland and cable path.
3. Restore ferrule and tighten cap to lightly hold cable in place.
4. Fold signal cable screen back over outer sheath and ground beneath cable clamp.
In case of shielded cables, use metal cable glands for proper connection.
5. Connect wires to terminals using screwdriver.
6. Tighten cable gland.

The numbers in the graphics below refer to table Figure 4-3 Termination/configuration overview (Page 37).

If connected as input or output - Field mount

	
Active configuration	Passive configuration
⑫ IO[3] (common)	⑬ IO[3]- (passive)
⑪ IO[3]+ (active)	⑫ IO[3] (common)
⏚ Functional Earth	⏚ Functional Earth

Table 4-1 If connected as input or output - Wall mount

	
Active configuration	Passive configuration

⑫	IO[3] (common)	⑬	IO[3]- (passive)
⑪	IO[3]+ (active)	⑫	IO[3] (common)

Termination example for channel 3

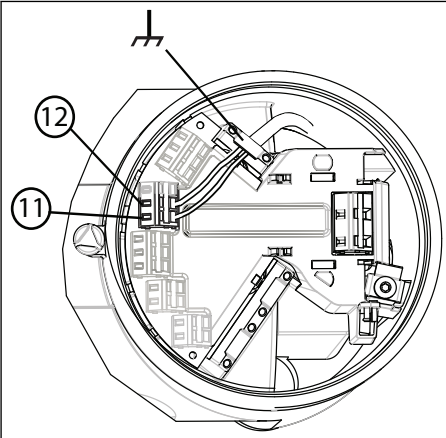
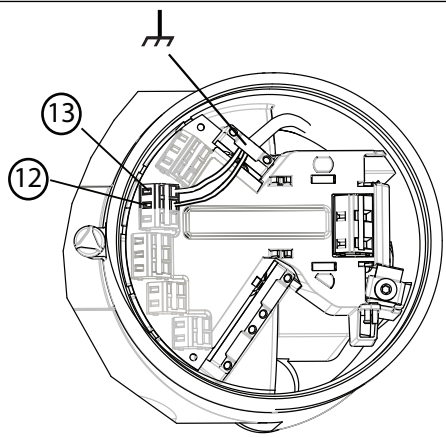
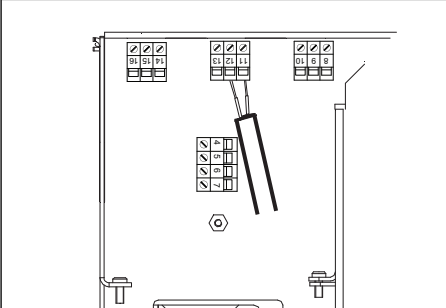
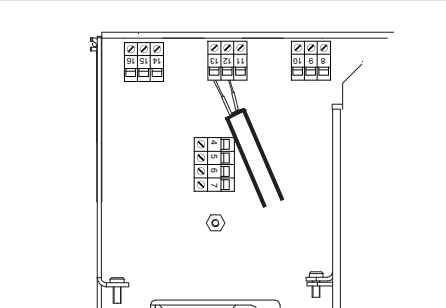
If connected as relay (channels 3 and 4 only)

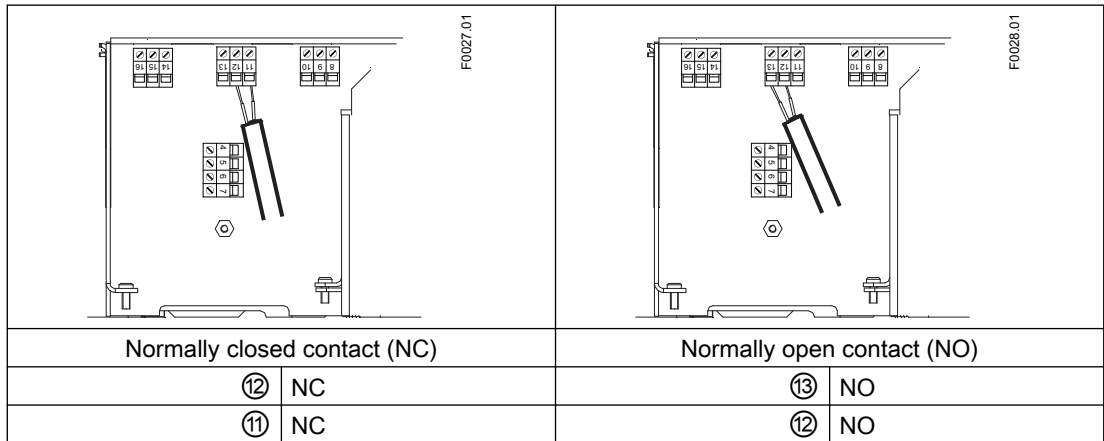

Termination example for channel 3 - relay connection

4.2.2.7 Input/output configuration

All pressure values are handled as absolute pressure. If connected pressure transmitters measure the pressure in gauge pressure, then please convert to absolute pressure by using the scaling functionality of the flow transmitters current input channel.

Configura-tion	Software configuration	Channel			
		2	3	4	
Output Active	Current output Frequency output Pulse output Digital output <ul style="list-style-type: none"> Alarm class Alarm item NAMUR status signals 	X	X	X	<p>Active</p>
Output Passive	Current output Frequency output Pulse output Digital output <ul style="list-style-type: none"> Alarm class Alarm item NAMUR status signals 	X	X	X	<p>Passive</p>

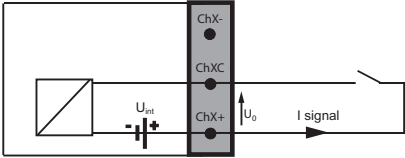
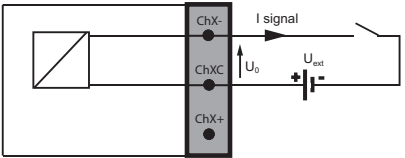
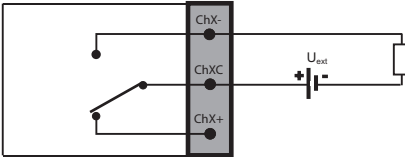
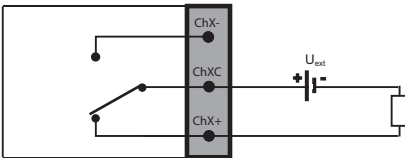
Configura- tion	Software configuration	Channel			
		2	3	4	
Input Active	Digital input <ul style="list-style-type: none"> Reset totalizer 1 Reset totalizer 2 Reset totalizer 3 Reset all totalizers Force outputs Freeze process values Zero adjust 		X	X	 <p>Active</p>
Input Passive	Digital input <ul style="list-style-type: none"> Reset totalizer 1 Reset totalizer 2 Reset totalizer 3 Reset all totalizers Force outputs Freeze process values Zero adjust 		X	X	 <p>Passive</p>
Relay output Normally open	Alarm class Alarm item NAMUR status signals		X	X	 <p>Normally open</p>
Relay output Normally closed	Alarm class Alarm item NAMUR status signals		X	X	 <p>Normally closed</p>

4.2.2.8 Connecting the power supply - Field mount

1. Flip open power supply terminal protection cover.
2. Remove cap and ferrule from cable gland and slide onto cable.

3. Push cable through open gland and cable path.

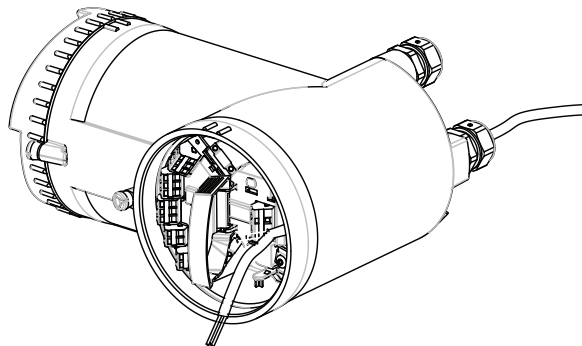

4. Restore ferrule and tighten cap to lightly hold cable in place.
5. Connect ground to terminal \oplus and power to terminals L/+ and N/- using wiring tool in the manner shown below at right.

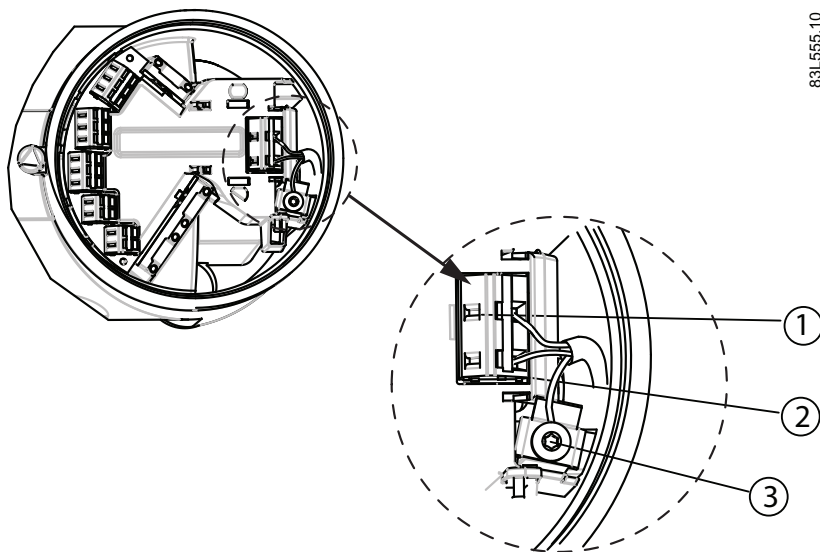

83L555.10

①	L/+
②	N/-
③	\oplus Protective Earth (PE)

AC connection	DC connection																		
<table border="0"> <tr> <td style="border: 1px solid black; padding: 2px;">L/+</td> <td style="padding: 0 10px;">←</td> <td>L</td> </tr> <tr> <td style="border: 1px solid black; padding: 2px;">N/-</td> <td style="padding: 0 10px;">←</td> <td>N</td> </tr> <tr> <td style="border: 1px solid black; padding: 2px;">\oplus</td> <td style="padding: 0 10px;"></td> <td>\oplus</td> </tr> </table> <p>Power: 100 to 240 V AC, 47 to 63 Hz</p>	L/+	←	L	N/-	←	N	\oplus		\oplus	<table border="0"> <tr> <td style="border: 1px solid black; padding: 2px;">L/+</td> <td style="padding: 0 10px;">←</td> <td>+</td> </tr> <tr> <td style="border: 1px solid black; padding: 2px;">N/-</td> <td style="padding: 0 10px;">←</td> <td>-</td> </tr> <tr> <td style="border: 1px solid black; padding: 2px;">\oplus</td> <td style="padding: 0 10px;"></td> <td>\oplus</td> </tr> </table> <p>Power: 19.2 to 28.8 V DC</p>	L/+	←	+	N/-	←	-	\oplus		\oplus
L/+	←	L																	
N/-	←	N																	
\oplus		\oplus																	
L/+	←	+																	
N/-	←	-																	
\oplus		\oplus																	

6. Close and latch power supply terminal protection cover.
7. Tighten cable gland.

4.2.2.9 Connecting the power supply - Wall mount

1. Open enclosure lid, unscrew power supply terminal protection cover screw, and remove protection cover.
2. Remove blind plug and fit cable gland.
3. Push cable through open gland and cable path

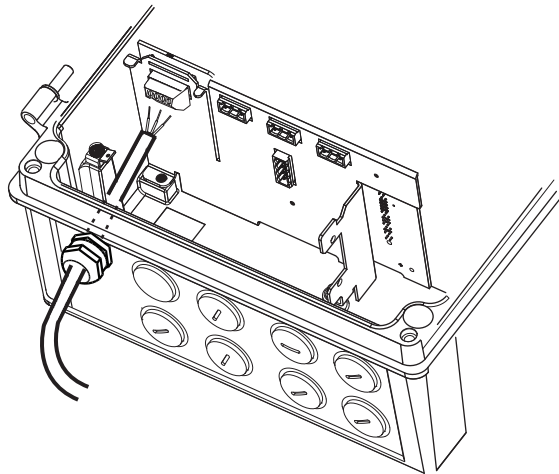

4. Restore ferrule and tighten cap to lightly hold cable in place.

- Connect ground to terminal \oplus and power to terminals L/+ and N/- in the manner shown below at right using a screwdriver.

Note

The terminal box is detachable

For easier access unplug the terminal box. After connecting the wires, plug the terminal box back in.

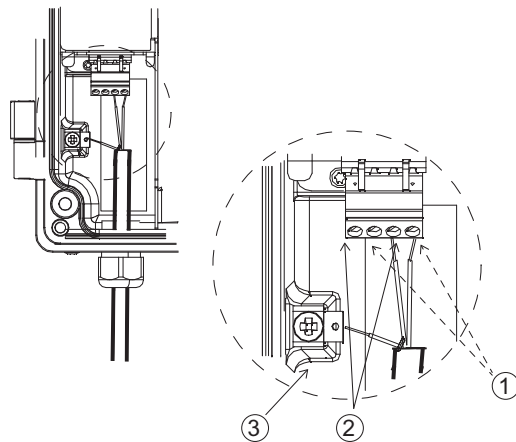

- ① L/
+
- ② N/
-
- ③ \oplus Protective Earth (PE)

AC connection	DC connection												
<table border="1"> <tr> <td>L/+</td> <td>← L</td> </tr> <tr> <td>N/-</td> <td>← N</td> </tr> <tr> <td>\oplus</td> <td>\oplus</td> </tr> </table>	L/+	← L	N/-	← N	\oplus	\oplus	<table border="1"> <tr> <td>L/+</td> <td>← +</td> </tr> <tr> <td>N/-</td> <td>← -</td> </tr> <tr> <td>\oplus</td> <td>\oplus</td> </tr> </table>	L/+	← +	N/-	← -	\oplus	\oplus
L/+	← L												
N/-	← N												
\oplus	\oplus												
L/+	← +												
N/-	← -												
\oplus	\oplus												
Power: 100 to 240 V AC, 47 to 63 Hz	Power: 19.2 to 28.8 V DC												

- Tighten cable gland.
- Mount power supply protection cover and fasten protection cover screw.

4.2.2.10 Finishing the transmitter connection

Connection check-up

- Check individual wire installation by tugging firmly.
- Firmly tighten cable glands and insert blanking plugs in unused cable entries.
- Close lid.

4. Tighten the four spring screws.
5. Ensure that moisture does not penetrate to inside of electronics enclosure.

Your device is now ready for commissioning.

5.1 Basic safety notes

DANGER

Toxic gases and liquids

Danger of poisoning when venting the device: if toxic process media are measured, toxic gases and liquids can be released.

- Before venting ensure that there are no toxic gases or liquids in the device, or take the appropriate safety measures.

WARNING

Improper commissioning in hazardous areas

Device failure or risk of explosion in hazardous areas.

- Do not commission the device until it has been mounted completely and connected in accordance with the information in Installing/mounting (Page 19).
- Before commissioning take the effect on other devices in the system into account.

WARNING

Commissioning and operation with pending error

If an error message appears, correct operation in the process is no longer guaranteed.

- Check the gravity of the error.
- Correct the error.
- If the error still exists:
 - Take the device out of operation.
 - Prevent renewed commissioning.

WARNING

Hot surfaces

Risk of burns resulting from hot surfaces.

- Take corresponding protective measures, for example by wearing protective gloves.

 WARNING
Hazardous contact voltage
Risk of injury through hazardous contact voltage when the device is open or not completely closed.
The degree of protection specified on the nameplate or in Technical data (Page 61) is no longer guaranteed if the device is open or not properly closed.
<ul style="list-style-type: none">• Make sure that the device is securely closed.

 WARNING
Loss of explosion protection
Risk of explosion in hazardous areas if the device is open or not properly closed.
<ul style="list-style-type: none">• Close the device as described in Installing/mounting (Page 19).

 WARNING
Opening device in energized state
Risk of explosion in hazardous areas
<ul style="list-style-type: none">• Only open the device in a de-energized state.• Check prior to commissioning that the cover, cover locks, and cable inlets are assembled in accordance with the directives.
Exception: Devices having the type of protection "Intrinsic safety Ex i" may also be opened in energized state in hazardous areas.

 WARNING
Hazardous gases in the enclosure
Risk of explosion.
Hazardous gases are gases that can explode and have a gas concentration of more than 25% of the lower explosion limit (LEL). Under normal ambient conditions the LEL is the risk threshold when handling these gases. However, special operating conditions can lower the potential risk from these gases under the LEL. A value of 25% of the LEL is regarded as definitely safe.
<ul style="list-style-type: none">• Do not introduce combustible or hazardous gases into a restricted-breathing enclosure (type of protection Ex nR).

 **WARNING**

Dust in pressurized enclosure "Type of protection Ex p"

An explosive dust atmosphere inside an enclosure can result in an explosion.

- In Zones 21 and 22: Remove the dust layers manually from the enclosure.
- Cleaning by pre-purging is not permitted.

 **WARNING**

Loss of type of protection

Risk of explosion. Damage to device if the enclosure is open or not properly closed. The type of protection specified on the nameplate or in Technical data (Page 61) is no longer guaranteed.

- Make sure that the device is securely closed.

Service and maintenance

6.1 Basic safety notes

Note

The device is maintenance-free.

The device is maintenance-free. However, a periodic inspection according to pertinent directives and regulations must be carried out.

An inspection can include, for example, check of:

- Ambient conditions
- Seal integrity of the process connections, cable entries, and cover
- Reliability of power supply, lightning protection, and grounds

WARNING

Dust layers above 5 mm

Risk of explosion in hazardous areas.

Device may overheat due to dust build up.

- Remove dust layers in excess of 5 mm.

WARNING

Leaks in the sample gas path

Risk of poisoning.

When measuring toxic process media, these can be released or collect in the device if there are leaks in the sample gas path.

- Purge the device as described in Commissioning (Page 51).
- Dispose of the toxic process media displaced by purging in an environmentally friendly manner.

WARNING

Use of a computer in a hazardous area

If the interface to the computer is used in the hazardous area, there is a risk of explosion.

- Ensure that the atmosphere is explosion-free (hot work permit).

 CAUTION
Releasing button lock Improper modification of parameters could influence process safety. <ul style="list-style-type: none">• Make sure that only authorized personnel may cancel the button locking of devices for safety-related applications.

NOTICE
Penetration of moisture into the device Device damage. <ul style="list-style-type: none">• Make sure when carrying out cleaning and maintenance work that no moisture penetrates the inside of the device.

6.2 Cleaning

Cleaning the enclosure

- Clean the outside of the enclosure with the inscriptions and the display window using a cloth moistened with water or a mild detergent.
- Do not use any aggressive cleansing agents or solvents, e.g. acetone. Plastic parts or the painted surface could be damaged. The inscriptions could become unreadable.

 WARNING
Electrostatic charge Risk of explosion in hazardous areas if electrostatic charges develop, for example, when cleaning plastic surfaces with a dry cloth. <ul style="list-style-type: none">• Prevent electrostatic charging in hazardous areas.

NOTICE
Improper cleaning of diaphragm Device damage. The diaphragm can be damaged. <ul style="list-style-type: none">• Do not use sharp or hard objects to clean the diaphragm.

6.3 Maintenance and repair work

 **WARNING**

Impermissible repair of the device

- Repair must be carried out by Siemens authorized personnel only.

 **WARNING**

Impermissible repair and maintenance of the device

- Repair and maintenance must be carried out by Siemens authorized personnel only.

 **WARNING**

Impermissible repair of explosion protected devices

Risk of explosion in hazardous areas

- Repair must be carried out by Siemens authorized personnel only.

 **WARNING**

Maintenance during continued operation in a hazardous area

There is a risk of explosion when carrying out repairs and maintenance on the device in a hazardous area.

- Isolate the device from power.

- or -

- Ensure that the atmosphere is explosion-free (hot work permit).

 **WARNING**

Impermissible accessories and spare parts

Risk of explosion in areas subject to explosion hazard.

- Only use original accessories or original spare parts.
- Observe all relevant installation and safety instructions described in the instructions for the device or enclosed with the accessory or spare part.

 WARNING
Humid environment
Risk of electric shock.
<ul style="list-style-type: none">• Avoid working on the device when it is energized.• If working on an energized device is necessary, ensure that the environment is dry.• Make sure when carrying out cleaning and maintenance work that no moisture penetrates the inside of the device.

 WARNING
Enclosure open
Risk of explosion in hazardous areas as a result of hot components and/or charged capacitors inside the device.
To open the device in a hazardous area:
<ol style="list-style-type: none">1. Isolate the device from power.2. Observe the wait time specified in Technical data (Page 61) or on the warning sign before opening the device.3. Visually inspect sensor inlet and outlet.
Exception: Devices exclusively having the type of protection "Intrinsic safety Ex i" may be opened in an energized state in hazardous areas.

 WARNING
Improper connection after maintenance
Risk of explosion in areas subject to explosion hazard.
<ul style="list-style-type: none">• Connect the device correctly after maintenance.• Close the device after maintenance work.
Refer to Basic safety notes (Page 27).

 WARNING
Hot, toxic or corrosive process media
Risk of injury during maintenance work.
When working on the process connection, hot, toxic or corrosive process media could be released.
<ul style="list-style-type: none">• As long as the device is under pressure, do not loosen process connections and do not remove any parts that are pressurized.• Before opening or removing the device ensure that process media cannot be released.

⚠ CAUTION**Hot surfaces**

Risk of burns during maintenance work on parts having surface temperatures exceeding 70 °C (158 °F).

- Take corresponding protective measures, for example by wearing protective gloves.
- After carrying out maintenance, remount touch protection measures.

⚠ CAUTION**Hot parts in the device**

Temperatures that can burn unprotected skin may be present for some time after the device has been switched off.

- Observe the waiting time specified in Technical data (Page 61) or on the device before starting with maintenance work.

⚠ CAUTION**Hazardous voltage at open device**

Risk of electric shock when the enclosure is opened or enclosure parts are removed.

- Before you open the enclosure or remove enclosure parts, de-energize the device.
- If maintenance measures in an energized state are necessary, observe the particular precautionary measures. Have maintenance work carried out by qualified personnel.

6.4 Replacing the device

⚠ CAUTION**Corrosive substances**

Risk of chemical burns when replacing the sensor.

The sensor in the device contains corrosive substances that result in burns on unprotected skin.

- Make sure that the sensor enclosure is not damaged when replacing the sensor.
- If contact with the corrosive substances occurs, rinse the affected skin immediately with large amount of water to dilute substance.

6.5 Return procedure

Enclose the bill of lading, return document and decontamination certificate in a clear plastic pouch and attach it firmly to the outside of the packaging.

Required forms

- Delivery note
- Return goods delivery note (<http://www.siemens.com/processinstrumentation/returngoodsnote>)
with the following information:
 - Product (item description)
 - Number of returned devices/replacement parts
 - Reason for returning the item(s)
- Decontamination declaration (<http://www.siemens.com/sc/declarationofdecontamination>)
With this declaration you warrant "that the device/replacement part has been carefully cleaned and is free of residues. The device/replacement part does not pose a hazard for humans and the environment."
If the returned device/replacement part has come into contact with poisonous, corrosive, flammable or water-contaminating substances, you must thoroughly clean and decontaminate the device/replacement part before returning it in order to ensure that all hollow areas are free from hazardous substances. Check the item after it has been cleaned. Any devices/replacement parts returned without a decontamination declaration will be cleaned at your expense before further processing.

6.6 Disposal



Devices described in this manual should be recycled. They may not be disposed of in the municipal waste disposal services according to the Directive 2012/19/EC on waste electronic and electrical equipment (WEEE).

Devices can be returned to the supplier within the EC, or to a locally approved disposal service for eco-friendly recycling. Observe the specific regulations valid in your country.

Further information about devices containing batteries can be found at: Information about battery / product return (WEEE) (<https://support.industry.siemens.com/cs/document/109479891/>)

Note

Special disposal required

The device includes components that require special disposal.

- Dispose of the device properly and environmentally through a local waste disposal contractor.
-

Technical data

7.1 Power

Table 7-1 Power supply

Description	Specification
Supply voltage	<ul style="list-style-type: none"> • 100 to 240 V AC, 47 to 63 Hz 30 VA • 19,2 - 28,8 V DC 11 W
Environmental conditions:	<ul style="list-style-type: none"> • Transient over voltages up to the levels of overvoltage category II • Temporary over voltages occurring on mains supply only • POLLUTION DEGREE 2. • MAINS AC supply voltage fluctuations up to ± 10 % of the nominal voltage. • Altitude up to 2 000 m
Reverse polarity protection (y / n)	Y
Galvanic isolation	2500 V AC

7.2 Bus communication

Table 7-2 HART, Modbus and Profibus communication

Description	Specification	More information
Manufacturer ID	42 (2A Hex)	Manufacturer ID parameter
Device ID	34 (22 Hex)	Device type parameter
HART protocol revision	7.5	HART protocol revision parameter
Profibus profile	4.0	Profibus protocol revision parameter
Modbus RS-485 RTU	-	-
Number of device variables	11	Number of process values, both measured and derived
Physical layers supported	FSK	Frequency Shift Keyed
Loop-powered	No	4-wire device

7.3 Operating conditions

Table 7-3 Basic conditions

Description		Specification
Ambient temperature (°C[°F]) (Humidity max. 90 %)	Operation:	
	Transmitter without display	-40 to +60 [-40 to +140]
	Transmitter with display	-20 to +60 [-4 to +140]
Ambient temperature (°C[°F]) (Humidity max. 90 %)	Storage:	
	Transmitter without display	-40 to +70 [-40 to +158]
	Transmitter with display	-40 to +70 [-40 to +158]
Climate class		DIN 60721-3-4
Altitude		Up to 2000 m (6560 ft)
Relative humidity [%]		95
EMC performance		<ul style="list-style-type: none"> • Emission • EN 55011 / CISPR-11 • Immunity • EN/IEC 61326-1 (Industry) NAMUR NE 21

Table 7-4 Cleaning and sterilizing conditions



Description	Specification
Cleaning method	<ul style="list-style-type: none"> • CIP • SIP
Cleaning temperature	On request
Cleaning frequency	On request
Cleaning duration	On request

Table 7-5 Process media conditions

Description	Specification
Process media temperature (T _s) (min to max) [°C (F)]	-10 to +140
<ul style="list-style-type: none"> • DIN11851/ SMS1145/ DIN32676 	
Process media temperature (T _s) (min to max) [°C (F)]	-50 up to +205 (-58 to +401)
<ul style="list-style-type: none"> • DN15 - DN150 	
Process media density (min to max) [kg/m ³ (lb/ft ³)]	1 to 5000 (0.06 to 312)
Process media gauge pressure (min to max) [bar (psi)]	0 to 100 (0 to 1450)
Process media absolute pressure (min to max) [bar (psi)]	Stainless steel: 1 to 101 (14.5 to 1465)
Process media viscosity	Gases and non-compressible liquids

Description	Specification
Pressure drop	See Siemens Sizing & Calculation tool (https://www.pia-portal.automation.siemens.com/SIE(cz1TSUQIM2FBTk9OJTNhREVGVEhXOTISMjBfUjNQXzAxJTNhc2NGUmVQQk14SWFISTRzV2V1OFQ4c3cxazB0aGR0RkJPZGJXV3dTWC1BVFQ=)/Z3_PIA_PORTAL/~flNUQVRFPTe2OTcuMDA0LjAxLjAx?~okcode=EV_CAL). Select "Flow" > "SITRANS F C sizing".
Pressure temperature ratings	See Operating Instructions for FC330

7.4 Certificates and approvals

Specification	Ex marking ATEX/IECEX	Ex marking FM/CSA
Flameproof and Intrinsic Safety		
FCT030 transmitter (can be installed in Zone 1 for gas and Zone 21 for dust)	 II 2(1) GD Ex db eb ia [ja Ga] IIC T6 Gb Ta = -40°C to +60°C  II 2(1) GD Ex tb [ja Da] IIIC T85°C Db	Class I, II, III Division 1 Gp A, B, C, D, E, F, G Class I Zone 1: AEx db eb ia [ja Ga] IIC T6 Gb Zone 21: AEx tb [ja Da] IIIC T85°C Db Ta = -40°C to +60°C
Flameproof, Increased Safety and Intrinsically Safe		
FC330 compact system (can be installed in Zone 1 for gas)	 II 1/2 (1) G Ex db eb ia [ja Ga] IIC/IIB T* Ga/Gb Ta = -40°C to +60°C * Temperature class (dependent on the process temperature and the ambient temperature, see Use in hazardous areas (Page 17))	Class I Division 1 Gp A, B, C, D Class I, Zone 1 AEx db eb ia [ja Ga] IIC/IIB Gb Ta = -40°C to +60°C

Hygienic version	EHEDG (<i>in preparation</i>)
Pressure equipment	<ul style="list-style-type: none"> 2014/68/EU Pressure Equipment Directive (PED) Canadian Registration Number (CRN) (<i>in preparation</i>)

Certificates and support

A.1 Technical support

Technical support

If this documentation does not provide complete answers to any technical questions you may have, contact Technical Support at:

- Support request (<http://www.siemens.com/automation/support-request>)
- More information about our Technical Support is available at Technical Support (<http://www.siemens.com/automation/csi/service>)

Internet Service & Support

In addition to our documentation, Siemens provides a comprehensive support solution at:

- Service & Support (<http://www.siemens.com/automation/service&support>)

Personal contact

If you have additional questions about the device, please contact your Siemens personal contact at:

- Partner (<http://www.automation.siemens.com/partner>)

To find the personal contact for your product, go to "All Products and Branches" and select "Products & Services > Industrial Automation > Process Instrumentation".

Documentation

You can find documentation on various products and systems at:

- Instructions and manuals (<http://www.siemens.com/processinstrumentation/documentation>)

A.2 Certificates

You can find certificates on the Internet at Industry online support portal (<http://www.siemens.com/processinstrumentation/certificates>) or on an included DVD.

Index

A

Approval nameplate
 Sensor, 11
 Transmitter, 10

B

Bus communication, 61

C

Cable specifications, 31
Certificates, 15, 65
Certificates and approvals, 63
Cleaning, 56
Compact Operating Instructions, 65
Connecting, 37, 41
Customer Support, (Refer to Technical support)

D

Device
 Identification, 6
Disassembly, 26
Disposal, 60
Document history, 5
Documentation, 65
 Edition, 5

E

Electrical connection
 Cable specifications, 31

F

Flow direction, 23

H

HART
 connecting, 37

Hazardous area
 Laws and directives, 15
 Qualified personnel, 17
Hotline, (Refer to Support request)

I

Identification nameplate
 Sensor, 7
 Transmitter, 6
Installation
 Gas, 23
 Indoor/outdoor, 20
 Inlet / Outlet conditions, 22
 Liquid, 23
 Location in the system, 22
 Orienting the sensor, 25
 Upstream / Downstream, 22
Instructions and manuals, 65

L

Laws and directives
 Disassembly, 15
 Personell, 15

M

Maintenance, 55
Manuals, 65
Modifications
 correct usage, 16
 improper, 16

O

Operating Instructions, 65

P

Power supply, 61
PROFIBUS
 connecting, 41

Q

Qualified personnel, 17

R

Rated operating conditions, 62

Return procedure, 60

S

Scope of delivery, 13

Sensor orientation, (See Installation)

Service, 65

Service & Support, 65

Internet, 65

Specification nameplate

Sensor, 10

Transmitter, 9

Support, 65

Support request, 65

Symbols, (Refer to warning symbols)

T

Technical data

Power supply, 61

Technical support, 65

Partner, 65

Personal contact, 65

Test certificates, 15

W

Warning symbols, 15

Warranty, 14

FINE CONTROLS (UK) LTD



Fine Controls have been supplying process controls & instrumentation equipment since 1994, & now serves an ever expanding customer base, both in the UK & globally.

We offer a full range of valve & instrumentation products & services, with our product range representing leading technologies & brands:

Flow: Flow Meters & Transmitters, Flow Switches, Flow Control Valves & Batch Control Systems

Temperature: Temperature Probes & Thermowells, Temperature transmitters, Temperature Regulators & Temperature Displays

Level: Level Transmitters & Switches

Pressure: Pressure Gauges & Transmitters, Precision & High Pressure Regulators & I-P Converters, Volume boosters.

Precision Pneumatics: Pressure Regulators, I-P Converters, Volume Boosters, Vacuum Regulators

Valves: Solenoid & Pneumatic Valves, Control Valves & Positioners, Actuated Ball, Globe or Diaphragm Valves & Isolation Valves

Services: Repair, Calibration, Panel Build, System Design & Commissioning

A rotork® Brand
FAIRCHILD



bürkert



SIEMENS



alcon
SOLENOID VALVES

A rotork® Brand



MIDLAND-ACS
A rotork® Brand



Honeywell



Bourdon
Baumer Group



SOLDO
CONTROLS

A rotork® Brand



Fine Controls (UK) LTD, Bassendale Road, Croft Business Park,
Bromborough, Wirral, CH62 3QL UK
Tel: 0151 343 9966
Email: sales@finecontrols.com