

Temperature Measurement

Transmitters for rail mounting

SITRANS TR200
two-wire system, universal

Overview



Ultra flexible - with the universal SITRANS TR200 transmitter

- Two-wire devices for 4 to 20 mA
- Enclosure for rail mounting
- Universal input for virtually any type of temperature sensor
- Configurable over PC

Benefits

- Compact design
- Electrically isolated
- Test sockets for multimeters
- Diagnostics LED (green/red)
- Sensor monitoring open circuits and short-circuits
- Self-monitoring
- Configuration status stored in EEPROM
- Expanded diagnostic functions, such as slave pointer, operating hours counter, etc.
- Special characteristic
- Electromagnetic compatibility to EN 61326 and NE21
- SIL2 (with order code C20), SIL2/3 (with C23)

Application

SITRANS TR200 transmitters can be used in all industrial sectors. Their compact design enables simple mounting on standard DIN rails on-site in protective boxes or in control cabinets. The following sensors/signal sources can be connected over their universal input module:

- Resistance thermometers (2, 3 or 4-wire system)
- Thermocouples
- Resistance-based sensors and DC voltage sources

The output signal is a direct current from 4 to 20 mA in accordance with the sensor characteristic.

Transmitters of the "intrinsically safe" type of protection can be installed within potentially explosive atmospheres. The devices comply with the Directive 94/9/EC (ATEX).

Function

The SITRANS TR200 is configured over a PC. A USB or RS 232 modem is linked to the output terminals for this purpose. The configuration data can now be edited using the SIPROM T software tool. The configuration data are then permanently stored in the non-volatile memory (EEPROM).

Once the sensors and power supply have been correctly connected, the transmitter outputs a temperature-linear output signal and the diagnostics LED displays a green light. In the case of a sensor short-circuit, the LED flashes red, an internal device fault is indicated by a steady red light.

The test socket can be used to connect an ammeter at any time for monitoring purposes and plausibility checks. The output current can be read without any interruption, or even without opening the current loop.

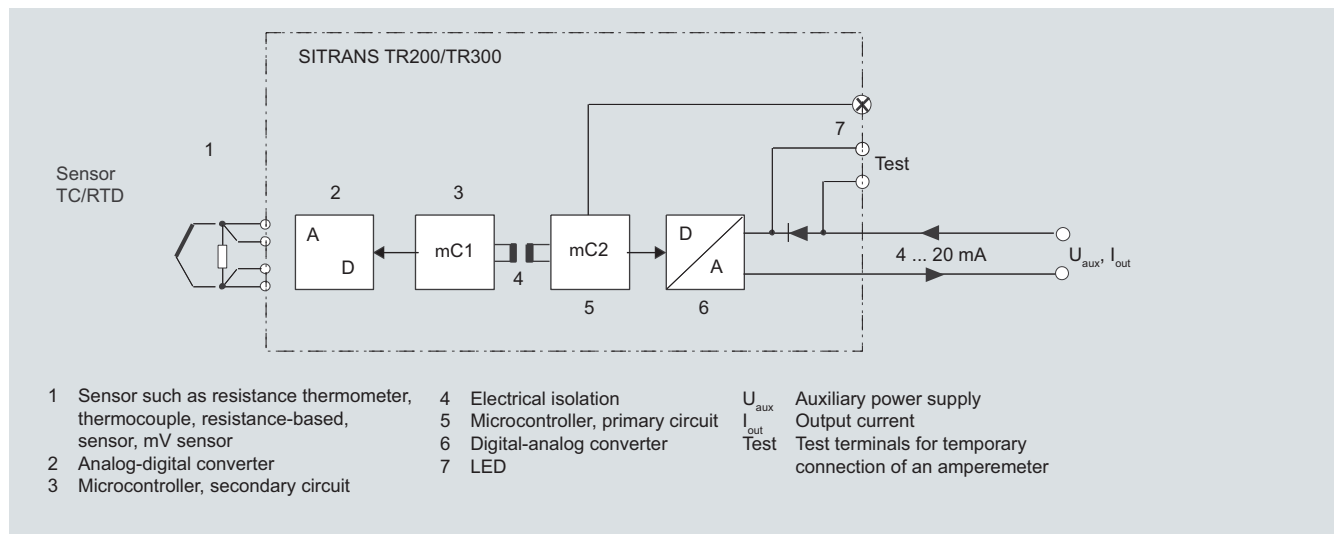

SITRANS TR200 function diagram

Technical specifications

Input

Resistance thermometer

Measured variable	Temperature
Sensor type	<ul style="list-style-type: none"> • to IEC 60751 Pt25 ... 1000 • to JIS C 1604; $a=0.00392 \text{ K}^{-1}$ Pt25 ... 1000 • to IEC 60751 Ni25 ... 1000 • Special type over special characteristic (max. 30 points)
Sensor factor	0.25 ... 10 (adaptation of the basic type, e.g. Pt100 to version Pt25 ... 1000)
Units	°C or °F
Connection	
• Standard connection	1 resistance thermometer (RTD) in 2-wire, 3-wire or 4-wire system
• Generation of average value	2 resistance thermometers in 2-wire system for generation of average temperature
• Generation of difference	2 resistance thermometers (RTD) in 2-wire system (RTD 1 – RTD 2 or RTD 2 – RTD 1)
Interface	
• Two-wire system	Parameterizable line resistance $\leq 100 \Omega$ (loop resistance)
• Three-wire system	No balancing required
• Four-wire system	No balancing required
Sensor current	$\leq 0.45 \text{ mA}$
Response time T_{63}	$\leq 250 \text{ ms}$ for 1 sensor with open-circuit monitoring
Open-circuit monitoring	Always active (cannot be disabled)
Short-circuit monitoring	can be switched on/off (default value: ON)
Measuring range	parameterizable (see table "Digital measuring errors")
Min. measured span	10 °C (18 °F)
Characteristic curve	Temperature-linear or special characteristic

Resistance-based sensors

Measured variable	Actual resistance
Sensor type	Resistance-based, potentiometers
Units	Ω
Connection	
• Normal connection	1 resistance-based sensor (R) in 2-wire, 3-wire or 4-wire system
• Generation of average value	2 resistance-based sensors in 2-wire system for generation of average value
• Generation of difference	2 resistance thermometers in 2-wire system (R1 – R2 or R2 – R1)
Interface	
• Two-wire system	Parameterizable line resistance $\leq 100 \Omega$ (loop resistance)
• Three-wire system	No balancing required
• Four-wire system	No balancing required
Sensor current	$\leq 0.45 \text{ mA}$
Response time T_{63}	$\leq 250 \text{ ms}$ for 1 sensor with open-circuit monitoring
Open-circuit monitoring	Always active (cannot be disabled)

Short-circuit monitoring	can be switched on/off (default value: OFF)
Measuring range	parameterizable max. 0 ... 2200 Ω (see table "Digital measuring errors")
Min. measured span	5 ... 25 Ω (see table "Digital measuring errors")
Characteristic curve	Resistance-linear or special characteristic
<u>Thermocouples</u>	
Measured variable	Temperature
Sensor type (thermocouples)	
• Type B	Pt30Rh-Pt16Rh to DIN IEC 584
• Type C	W5 %-Re acc. to ASTM 988
• Type D	W3 %-Re acc. to ASTM 988
• Type E	NiCr-CuNi to DIN IEC 584
• Type J	Fe-CuNi to DIN IEC 584
• Type K	NiCr-Ni to DIN IEC 584
• Type L	Fe-CuNi to DIN 43710
• Type N	NiCrSi-NiSi to DIN IEC 584
• Type R	Pt13Rh-Pt to DIN IEC 584
• Type S	Pt10Rh-Pt to DIN IEC 584
• Type T	Cu-CuNi to DIN IEC 584
• Type U	Cu-CuNi to DIN 43710
Units	°C or °F
Connection	
• Standard connection	1 thermocouple (TC)
• Generation of average value	2 thermocouples (TC)
• Generation of difference	2 thermocouples (TC) (TC1 – TC2 or TC2 – TC1)
Response time T_{63}	$\leq 250 \text{ ms}$ for 1 sensor with open-circuit monitoring
Open-circuit monitoring	Can be switched off
Cold junction compensation	
• Internal	With integrated Pt100 resistance thermometer
• External	With external Pt100 IEC 60571 (2-wire or 3-wire connection)
• External fixed	Cold junction temperature can be set as fixed value
Measuring range	parameterizable (see table "Digital measuring errors")
Min. measured span	Min. 40 ... 100 °C (72 ... 180 °F) (see table "Digital measuring errors")
Characteristic curve	Temperature-linear or special characteristic
<u>mV sensor</u>	
Measured variable	DC voltage
Sensor type	DC voltage source (DC voltage source possible over an externally connected resistor)
Units	mV
Response time T_{63}	$\leq 250 \text{ ms}$ for 1 sensor with open-circuit monitoring
Open-circuit monitoring	Can be switched off
Measuring range	parameterizable max. -100 ... 1100 mV
Min. measured span	2 mV or 20 mV
Overload capability of the input	-1.5 ... +3.5 V DC
Input resistance	$\geq 1 \text{ M}\Omega$
Characteristic curve	Voltage-linear or special characteristic

Temperature Measurement

Transmitters for rail mounting

SITRANS TR200

two-wire system, universal

Output

Output signal	4 ... 20 mA, 2-wire
Auxiliary power	11 ... 35 V DC (to 30 V with Ex)
Max. load	$(U_{aux} - 11 \text{ V})/0.023 \text{ A}$
Overrange	3.6 ... 23 mA, infinitely adjustable (default range: 3.84 mA ... 20.5 mA)
Error signal (e.g. following sensor fault) (conforming to NE43)	3.6 ... 23 mA, infinitely adjustable (default value: 22.8 mA)
Sample cycle	0.25 s nominal
Damping	Software filter 1st order 0 ... 30 s (parameterizable)
Protection	Against reversed polarity
Electrically isolated	Input against output 2.12 kV DC (1.5 kV _{eff} AC)

Measuring accuracy

Digital measuring errors	See Table "Digital measuring errors"
Reference conditions	
• Auxiliary power	24 V ± 1 %
• Load	500 Ω
• Ambient temperature	23 °C
• Warming-up time	> 5 min
Error in the analog output (digital/analog converter)	< 0.025 % of span
Error due to internal cold junction	< 0.5 °C (0.9 °F)
Influence of ambient temperature	
• Analog measuring error	0.02 % of span/10 °C (18 °F)
• Digital measuring errors	
- With resistance thermometer	0.06 °C (0.11 °F)/10 °C (18 °F)
- with thermocouples	0.6 °C (1.1 °F)/10 °C (18 °F)
Auxiliary power effect	< 0.001 % of span/V
Effect of load impedance	< 0.002 % of span/100 Ω
Long-term drift	
• In the first month	< 0.02 % of span in the first month
• After one year	< 0.2 % of span after one year
• After 5 years	< 0.3 % of span after 5 years

Conditions of use

Ambient conditions

Ambient temperature range	-40 ... +85 °C (-40 ... +185 °F)
Storage temperature range	-40 ... +85 °C (-40 ... +185 °F)
Relative humidity	< 98 %, with condensation
Electromagnetic compatibility	acc. to EN 61326 and NE21

Construction

Material	Plastic, electronic module potted
Weight	122 g
Dimensions	See "Dimensional drawings"
Cross-section of cables	Max. 2.5 mm ² (AWG 13)
Degree of protection to IEC 60529	
• Enclosure	IP20

Certificates and approvals

Explosion protection ATEX	
EC type test certificate	PTB 07 ATEX 2032X
• "Intrinsic safety" type of protection	II 2(1) G Ex ia/ib IIC T6/T4 II 3(1) G Ex ia/ic IIC T6/T4 II 3 G Ex ic IIC T6/T4 II 2(1) D Ex iaD/ibD 20/21 T115 °C
• Type of protection, "equipment is non-arcing"	II 3 G Ex nA IIC T6/T4
Other approvals	GOST

Software requirements for SIPROM T

PC operating system	Windows ME, 2000 and XP; also Windows 95, 98 and 98 SE, but only in connection with RS 232 modem.
---------------------	---

Factory setting:

- Pt100 (IEC 751) with 3-wire circuit
- Measuring range: 0 ... 100 °C (32 ... 212 °F)
- Error signal in the event of sensor breakage: 22.8 mA
- Sensor offset: 0 °C (0 °F)
- Damping 0.0 s

Digital measuring errors

Resistance thermometer

Input	Measuring range °C/(°F)	Min. measured span		Digital accuracy	
		°C	(°F)	°C	(°F)
to IEC 60751					
Pt25	-200 ... +850 (-328 ... +1562)	10	(18)	0.3	(0.54)
Pt50	-200 ... +850 (-328 ... +1562)	10	(18)	0.15	(0.27)
Pt100 ... Pt200	-200 ... +850 (-328 ... +1562)	10	(18)	0.1	(0.18)
Pt500	-200 ... +850 (-328 ... +1562)	10	(18)	0.15	(0.27)
Pt1000	-200 ... +350 (-328 ... +662)	10	(18)	0.15	(0.27)
to JIS C1604-81					
Pt25	-200 ... +649 (-328 ... +1200)	10	(18)	0.3	(0.54)
Pt50	-200 ... +649 (-328 ... +1200)	10	(18)	0.15	(0.27)
Pt100 ... Pt200	-200 ... +649 (-328 ... +1200)	10	(18)	0.1	(0.18)
Pt500	-200 ... +649 (-328 ... +1200)	10	(18)	0.15	(0.27)
Pt1000	-200 ... +350 (-328 ... +662)	10	(18)	0.15	(0.27)
Ni 25 to Ni1000	-60 ... +250 (-76 ... +482)	10	(18)	0.1	(0.18)

Temperature Measurement

Transmitters for rail mounting

SITRANS TR200
two-wire system, universal

Resistance-based sensors

Input	Measuring range	Min. measured span	Digital accuracy
	Ω	Ω	Ω
Resistance	0 ... 390	5	0.05
Resistance	0 ... 2200	25	0.25

Thermocouples

Input	Measuring range	Min. measured span		Digital accuracy	
	°C/(°F)	°C	(°F)	°C	(°F)
Type B	0 ... 1820 (32 ... 3308)	100	(180)	2 ¹⁾	(3.6) ¹⁾
Type C (W5)	0 ... 2300 (32 ... 4172)	100	(180)	2	(3.6)
Type D (W3)	0 ... 2300 (32 ... 4172)	100	(180)	1 ²⁾	(1.8) ²⁾
Type E	-200 ... +1000 (-328 ... +1832)	50	(90)	1	(1.8)
Type J	-210 ... +1200 (-346 ... +2192)	50	(90)	1	(1.8)
Type K	-230 ... +1370 (-382 ... +2498)	50	(90)	1	(1.8)
Type L	-200 ... +900 (-328 ... +1652)	50	(90)	1	(1.8)
Type N	-200 ... +1300 (-328 ... +2372)	50	(90)	1	(1.8)
Type R	-50 ... +1760 (-58 ... +3200)	100	(180)	2	(3.6)
Type S	-50 ... +1760 (-58 ... +3200)	100	(180)	2	(3.6)
Type T	-200 ... +400 (-328 ... +752)	40	(72)	1	(1.8)
Type U	-200 ... +600 (-328 ... +1112)	50	(90)	2	(3.6)

¹⁾ The digital accuracy in the range 0 to 300 °C (32 to 572 °F) is 3 °C (5.4 °F).

²⁾ The digital accuracy in the range 1750 to 2300 °C (3182 to 4172 °F) is 2 °C (3.6 °F).

mV sensor

Input	Measuring range	Min. measured span	Digital accuracy
	mV	mV	μV
mV sensor	-10 ... +70	2	40
mV sensor	-100 ... +1100	20	400

The digital accuracy is the accuracy after the analog/digital conversion including linearization and calculation of the measured value.

An additional error is generated in the output current 4 to 20 mA as a result of the digital/analog conversion of 0.025 % of the set span (digital-analog error).

The total error under reference conditions at the analog output is the sum from the digital error and the digital-analog error (poss. with the addition of cold junction errors in the case of thermocouple measurements).

Selection and Ordering data

Order No.

Temperature transmitter SITRANS TR200

For mounting on a standard DIN rail, two-wire system, 4 to 20 mA, programmable, with electrical isolation, with documentation on CD

- Without explosion protection ▶ D) **7NG3032-0JN00**
- with explosion protection to ATEX ▶ D) **7NG3032-1JN00**

Further designs

Please add **"-Z"** to Order No. with and specify Order codes(s).

- | | |
|--|-------------------------|
| Customer-specific setting of operating data (specify operating data in plain text) | Y01¹⁾ |
| with test protocol (5 measuring points) | C11 |
| Functional safety SIL2 | C20 |
| Functional safety SIL2/3 | C23 |

Accessories

Order No.

Modem for SITRANS TH100, TH200 and TR200 incl. SIPROM T parameterization software

- | | |
|---|----------------------|
| With USB connection | ▶ 7NG3092-8KU |
| CD for measuring instruments for temperature | ▶ A5E00364512 |

With documentation in German, English, French, Spanish, Italian, Portuguese and SIPROM T parameterization software

▶ Available ex stock.

¹⁾ Y01: Quote all details that deviate from the factory setting (see below).

D) Subject to export regulations AL: N, ECCN: EAR99H.

Supply units see Chap. 8 "Supplementary Components".

Factory setting:

- Pt100 (IEC 751) with 3-wire circuit
- Measuring range: 0 ... 100 °C (32 ... 212 °F)
- Fault current: 22.8 mA
- Sensor offset: 0 °C (0 °F)
- Damping 0.0 s

Temperature Measurement Transmitters for rail mounting

SITRANS TR200
two-wire system, universal

3

Dimensional drawings

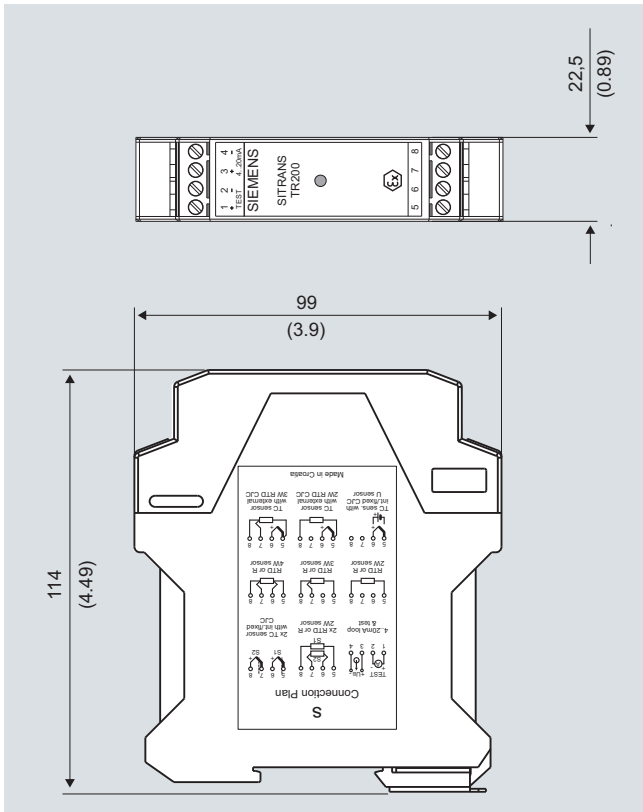

SITRANS TR200, dimensions in mm (inch)

Schematics

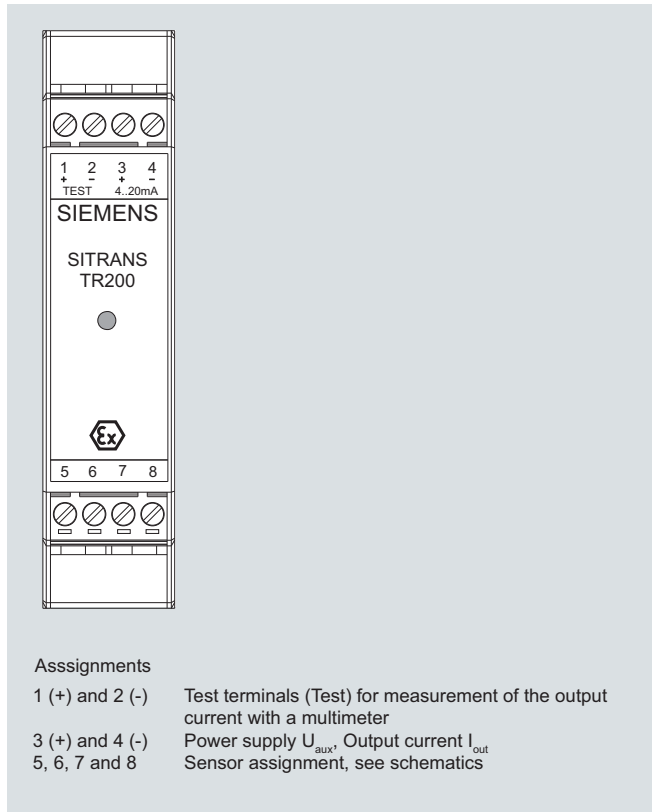

SITRANS TR200, pin assignment

Temperature Measurement Transmitters for rail mounting

SITRANS TR200
two-wire system, universal

3

Resistance thermometer

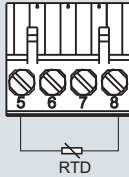

Two-wire system ¹⁾

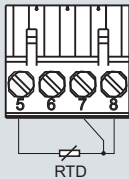

Three-wire system

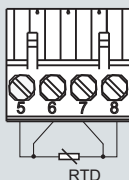

Four-wire system

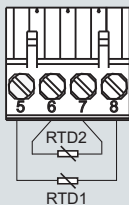

Generation of average value/difference ¹⁾

Resistance

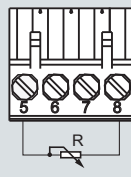

Two-wire system ¹⁾

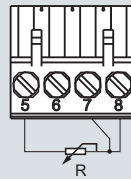

Three-wire system

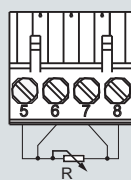

Four-wire system

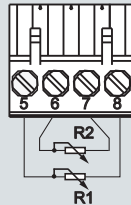

Generation of average value/difference ¹⁾

Thermocouple

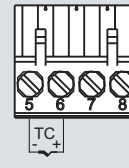

Cold junction compensation
Internal/fixed value

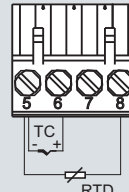

Cold junction compensation with
external Pt100 in two-wire system ¹⁾

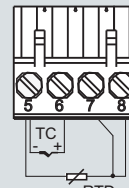

Cold junction compensation with
external Pt100 in three-wire system

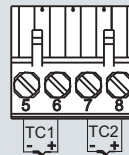

Generation of average value / difference
with internal cold junction compensation

¹⁾ Programmable line resistance for the purpose of correction.

Voltage measurement

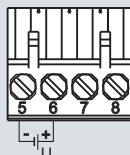

Current measurement

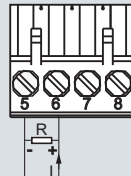

Test terminals

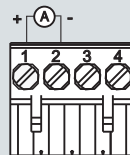

Power supply/
4 ... 20 mA (U_{aux})

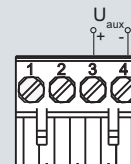

SITRANS TR200, sensor connection assignment

FINE CONTROLS (UK) LTD



Fine Controls have been supplying process controls & instrumentation equipment since 1994, & now serves an ever expanding customer base, both in the UK & globally.

We offer a full range of valve & instrumentation products & services, with our product range representing leading technologies & brands:

Flow: Flow Meters & Transmitters, Flow Switches, Flow Control Valves & Batch Control Systems

Temperature: Temperature Probes & Thermowells, Temperature transmitters, Temperature Regulators & Temperature Displays

Level: Level Transmitters & Switches

Pressure: Pressure Gauges & Transmitters, Precision & High Pressure Regulators & I-P Converters, Volume boosters.

Precision Pneumatics: Pressure Regulators, I-P Converters, Volume Boosters, Vacuum Regulators

Valves: Solenoid & Pneumatic Valves, Control Valves & Positioners, Actuated Ball, Globe or Diaphragm Valves & Isolation Valves

Services: Repair, Calibration, Panel Build, System Design & Commissioning

A rotork® Brand
FAIRCHILD



bürkert



SIEMENS



alcon
SOLENOID VALVES

A rotork® Brand



MIDLAND-ACS
A rotork® Brand



Honeywell



Bourdon
Baumer Group



SOLDO
CONTROLS

A rotork® Brand



Fine Controls (UK) LTD, Bassendale Road, Croft Business Park,
Bromborough, Wirral, CH62 3QL UK
Tel: 0151 343 9966
Email: sales@finecontrols.com