

# Flow Measurement

## SITRANS F US Inline

### Flowmeter FUE380 with approval

#### Overview



The 2-track flowmeter SITRANS FUE380 comes as battery or mains-powered and is designed to measure water flow in district heating plants, local networks, boiler stations, substations, chiller plants and other general water applications.

The flowmeter FUE380 is approved according to energy meter standards EN 1434 class 2, OIML R 75 class 2 and MID class 2. Metrological parameters are protected against manipulation. The type-approved flowmeter version is named SITRANS FUE380. For a standard flowmeter type FUS380 without a type approval, see separate FUS380 chapter.

Technically, the meter types SITRANS FUS380 and SITRANS FUE380 are completely identical, only difference is the calibration limit and the type approval for custody transfer.

#### Benefits

- Battery-powered up to 6 years
- 115/230 V mains-powered with back-up battery option in case of mains power failure
- Fast measuring frequency 20 Hz/0.5 Hz (230 V AC/Battery)
- Easy one-button straight forward display
- 2-track measuring principle for optimum accuracy
- Compact or remote mounting
- Measures on all district water qualities and water conductivities
- No pressure drop
- Long-term stability
- 2 galvanically isolated digital outputs for easy connection to a calculator (potential-free)
- Bidirectional measurement, with 2 totalizers and outputs
- Dynamic range  $Q_i:Q_p$  up to 1:50/100 or max. range  $Q_i:Q_s$  up to 1:400
- Modbus RTU/RS 232, RS 485

#### Application

The main application for SITRANS FUE380 is measurement of water flow or water flow in energy meter systems for custody transfer in district heating networks or chilled water. Combined with an energy calculator and a pair of temperature sensors, SITRANS FUE380 can be used as part of an energy meter system. For this purpose Siemens offers energy calculator SITRANS FUE950.

#### Design

The 2-track design of SITRANS FUE380 ensures maximum accuracy under short inlet conditions. The flowmeter consists of a flow sensor pipe, 4 transducers/transducer cables and an approved transmitter SITRANS FUE080.

The unit is available in a compact or a remote version with up to 30 meter distance from flowmeter to transmitter. When ordering a compact version the transducer cables are pre-mounted and ready for installation.

Compact mounting is only possible up to 120 °C (248 °F). The sensor must be isolated to protect transmitter from heat. The transmitter is available in an IP67/NEMA 4X/6 enclosure.

#### FUE380 MI-004 approval

The SITRANS FUE380 program is type-approved according to international energy meter standard EN1434. On 1 November 2006 the MI-004 energy meter directive became effective providing that all energy meters with a MI-004 verification label can be sold across the EU borders.

The FUE380 are MI-004 verified and labeled products according to Directive 2004/22/EC of the European Parliament and Council of March 31, 2004 on measuring instruments (MID), Annex MI-004 in sizes from DN 50 to DN 1200.

The MID certification is obtained as module B + module D approvals according to the above-mentioned directive.

Module B: Type approval according to EN1434: 2006

Module D: Quality insurance approval of production

The MID system label with the approval information is placed on the side of the transmitter and on the sensor. An example of the product label is shown below:



FUE380 transmitter MID label

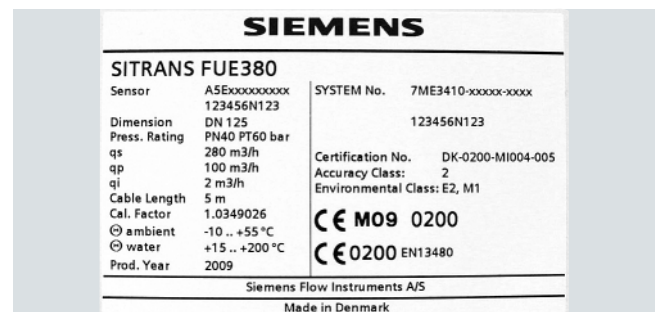

FUE380 sensor MID label

### Integration

The flowmeter digital output is often used as input for an energy meter or as input for digital systems for remote reading.

SITRANS FUE380 has two digital output functions that can be individually selected, and optional Modbus RTU communication modules.

Pulse output rate is defined when ordering.

If the flowmeter forms part of an energy meter system for custody transfer, no further approvals are needed, except possible local approvals on the flowmeter.

### Configuration SITRANS FUE380 type-approved

#### Selection guide SITRANS FUE380, type-approved flowmeter

DN	Q <sub>s</sub> (m <sup>3</sup> /h)	Q <sub>max</sub> (m <sup>3</sup> /h) (105% of Q <sub>s</sub> )	Q <sub>p</sub> (m <sup>3</sup> /h)	Q <sub>i</sub> (m <sup>3</sup> /h) (1:50 of Q <sub>p</sub> ) <sup>4)</sup>	Q <sub>i</sub> (m <sup>3</sup> /h) (1:100 of Q <sub>p</sub> ) <sup>4)</sup>	Cut-off (m <sup>3</sup> /h)	Cut-off (% of Q <sub>max</sub> )	Typical pulse value <sup>1)</sup> (l/pulse)
50	30	31.5	15 <sup>2)</sup>	0.3	0.15	0.075	0.24	1
50	45	47.25	15 <sup>2)</sup>	0.3	0.15	0.075	0.16	1
50	45	47.25	30 <sup>3)</sup>	-	0.30	0.150	0.32	1
65	50	52.5	25 <sup>2)</sup>	0.5	0.25	0.125	0.24	1
65	72	75.6	25 <sup>2)</sup>	0.5	0.25	0.125	0.17	1
65	72	75.6	50 <sup>3)</sup>	-	0.50	0.250	0.33	1
80	80	84	40 <sup>2)</sup>	0.8	0.40	0.200	0.24	2.5
80	120	126	40 <sup>2)</sup>	0.8	0.40	0.200	0.16	2.5
80	120	126	80 <sup>3)</sup>	-	0.80	0.400	0.32	2.5
100	120	126	60 <sup>2)</sup>	1.2	0.60	0.300	0.24	2.5
100	180	189	60 <sup>2)</sup>	1.2	0.60	0.300	0.16	2.5
100	180	189	120 <sup>3)</sup>	-	1.20	0.600	0.32	2.5
125	200	210	100 <sup>2)</sup>	2.0	1.00	0.500	0.24	2.5
125	280	294	100 <sup>2)</sup>	2.0	1.00	0.500	0.17	2.5
125	280	294	200 <sup>3)</sup>	-	2.00	1.000	0.34	2.5
150	300	315	150 <sup>2)</sup>	3.0	1.50	0.750	0.24	10
150	420	441	150 <sup>2)</sup>	3.0	1.50	0.750	0.17	10
150	420	441	300 <sup>3)</sup>	-	3.00	1.500	0.34	10
200	500	525	250 <sup>2)</sup>	5.0	2.50	1.250	0.24	10
200	700	735	250 <sup>2)</sup>	5.0	2.50	1.250	0.17	10
200	700	735	500 <sup>3)</sup>	-	5.00	2.500	0.34	10
250	800	840	400 <sup>2)</sup>	8.0	4.00	2.000	0.24	10
250	1120	1176	400 <sup>2)</sup>	8.0	4.00	2.000	0.17	10
250	1120	1176	800 <sup>3)</sup>	-	8.00	4.000	0.34	10
300	1120	1176	560 <sup>2)</sup>	11.2	5.60	2.800	0.24	50
300	1560	1638	560 <sup>2)</sup>	11.2	5.60	2.800	0.17	50
300	1560	1638	1120 <sup>3)</sup>	-	11.20	5.600	0.34	50
350	1500	1575	750 <sup>2)</sup>	15.0	7.50	3.750	0.24	50
350	2100	2205	750 <sup>2)</sup>	15.0	7.50	3.750	0.17	50
350	2100	2205	1500 <sup>3)</sup>	-	15.00	7.500	0.34	50
400	1900	1995	950 <sup>2)</sup>	19.0	9.50	4.750	0.24	50
400	2660	2793	950 <sup>2)</sup>	19.0	9.50	4.750	0.17	50
400	2660	2793	1900 <sup>3)</sup>	-	19.00	9.500	0.34	50
500	2950	3097.5	1475 <sup>2)</sup>	29.5	14.75	7.375	0.24	100
500	4130	4336.5	1475 <sup>2)</sup>	29.5	14.75	7.375	0.17	100
500	4130	4336.5	2950 <sup>3)</sup>	-	29.50	14.750	0.34	100

# Flow Measurement

## SITRANS F US Inline

### Flowmeter FUE380 with approval

DN	Q <sub>s</sub> (m <sup>3</sup> /h)	Q <sub>max</sub> (m <sup>3</sup> /h) (105% of Q <sub>s</sub> )	Q <sub>p</sub> (m <sup>3</sup> /h)	Q <sub>i</sub> (m <sup>3</sup> /h) (1:50 of Q <sub>p</sub> ) <sup>4)</sup>	Q <sub>i</sub> (m <sup>3</sup> /h) (1:100 of Q <sub>p</sub> ) <sup>4)</sup>	Cut-off (m <sup>3</sup> /h)	Cut-off (% of Q <sub>max</sub> )	Typical pulse value <sup>1)</sup> (l/pulse)
600	4300	4515	2150 <sup>2)</sup>	43.0	21.50	10.750	0.24	100
600	6020	6321	2150 <sup>2)</sup>	43.0	21.50	10.750	0.17	100
600	6020	6321	4300 <sup>3)</sup>	-	43.00	21.500	0.34	100
700	5800	6090	2900 <sup>2)</sup>	58.0	29.00	14.500	0.24	100
700	8120	8526	2900 <sup>2)</sup>	58.0	29.00	14.500	0.17	100
700	8120	8526	5800 <sup>3)</sup>	-	58.00	29.000	0.34	100
800	7600	7980	3800 <sup>2)</sup>	76.0	38.00	19.000	0.24	100
800	10 640	11 172	3800 <sup>2)</sup>	76.0	38.00	19.000	0.17	100
800	10 640	11 172	7600 <sup>3)</sup>	-	76.00	38.000	0.34	100
900	10 000	10 500	5000 <sup>2)</sup>	100.0	50.00	25.000	0.24	100
900	14 000	14 700	5000 <sup>2)</sup>	100.0	50.00	25.000	0.17	100
900	14 000	14 700	10 000 <sup>3)</sup>	-	100.00	50.000	0.34	100
1000	12 000	12 600	6000 <sup>2)</sup>	120.0	60.00	30.000	0.24	100
1000	16 800	17 640	6000 <sup>2)</sup>	120.0	60.00	30.000	0.17	100
1000	16 800	17 640	12 000 <sup>3)</sup>	-	120.00	60.000	0.34	100
1200	18 000	18 900	9000 <sup>2)</sup>	180.0	90.00	45.000	0.24	100
1200	25 200	26 460	9000 <sup>2)</sup>	180.0	90.00	45.000	0.17	100
1200	25 200	26 460	18 000 <sup>3)</sup>	-	180.00	90.000	0.34	100

Dynamic range Q<sub>i</sub>:Q<sub>p</sub>: better than 1:100 or 1:50 according to EN 1434, OIML R 75 class 2 and MID class 2.

Q<sub>i</sub> (Q<sub>min</sub>) means the minimal and Q<sub>p</sub> (Q<sub>nom</sub>) the nominal flow rate according to the approval requirements.

Q<sub>s</sub> is the highest operatable flow rate. The maximum flow rate (Q<sub>max</sub>) is 105 % of Q<sub>s</sub>. The low flow cut-off is 50 % of Q<sub>i</sub>.

Q<sub>i</sub>, Q<sub>p</sub> and Q<sub>s</sub> are shown on the system label of the FUE380.

In order to obtain best pulse output resolution in the range Q<sub>min</sub> to Q<sub>s</sub> of approx. 100 Hz at Q<sub>s</sub>, two or three flow values for every dimension can be selected at ordering. Therefore the ordering data table also shows Q<sub>p</sub> (Q<sub>n</sub>). This flow rate is between Q<sub>i</sub> (Q<sub>min</sub>) and Q<sub>s</sub> and indicates the normal or typical flow according to the approval requirements.

<sup>1)</sup> In connection with SITRANS FUE950 - other pulse values - see Selection and Ordering data table.

<sup>2)</sup> EN 1434 and MID flow values

<sup>3)</sup> OIML R 75 and MID flow values

<sup>4)</sup> The minimum flow (Q<sub>i</sub>) should be checked in the PIA-selector or product master data base (PMD)

# Flow Measurement

## SITRANS F US Inline

### Flowmeter FUE380 with approval

#### Technical specifications

Pipe design	2-track sensor with flanges and integrated transducers wet-calibrated from factory
Nominal size welded version	DN 50, 65, 80, 100, 125, 150, 200, 250, 300, 350, 400, 500, 600, 700, 800, 900, 1000, 1200
Pressure rate	PN 16, PN 25, PN 40 EN 1092-1
Pipe material	<ul style="list-style-type: none"> <li>DN 100 ... DN 1200: Carbon Steel EN 1.0345/P235 GH, painted in light-gray.</li> <li>DN 50 ... DN 80: Die-cast bronze G-CuSn10/W2.1050.01 (EN1982)</li> </ul>
Transducer design	<ul style="list-style-type: none"> <li>DN 100 ... DN 1200: Integrated version and welded onto the pipe</li> <li>DN 50 ... DN 80: Screwed into the pipe</li> </ul>
Transducer material	Stainless steel (AISI 316/1.4404)/brass (CuZn <sub>36</sub> Pb <sub>2</sub> As)

#### Sensor operating conditions

Storage	-40 ... +85 °C (-40 ... +185 °F)
Media/surface temperature	DN 100 ... DN 1200: <ul style="list-style-type: none"> <li>Remote: 2 ... 200 °C (35.6 ... 392 °F)</li> <li>MID: min. +15 °C/+59 °F</li> </ul> DN 50 ... DN 80: <ul style="list-style-type: none"> <li>Remote: 2 ... 150 °C (35.6 ... 302 °F)</li> <li>MID: min. +15 °C/+59 °F</li> </ul> DN 50 ... DN 1200: <ul style="list-style-type: none"> <li>Compact: 2 ... 120 °C (35.6 ... 248 °F)</li> <li>MID: min. +15 °C/+59 °F</li> </ul>
Degree of protection	Sensor connection IP67/NEMA 4X/6
Electromagnetic compatibility	<ul style="list-style-type: none"> <li>Emitted interference: To EN 61000-6-4</li> <li>Noise immunity: To EN 61000-6-2</li> <li>MID: Environment class E2 and M1</li> </ul>
Max. flow velocity at Q <sub>s</sub>	DN 50 ... DN 1200: 9 m/s (29.5 ft/s)

#### Transmitter

The transmitter related to this system is the SITRANS FUE080.

Technical specifications to the FUE080 see page 4/219 ff.

#### Sensor cable

Cable length	Max. 30 m (98.4 ft) between transmitter and sensor
--------------	--

#### Certificates and approvals

Conformity certificate	The devices are supplied as standard with a Siemens Certificate of Conformity on CD
Material certificate	Material certificate according EN 10204-3.1 is optionally available
Calibration report	A standard calibration report is shipped with every flowmeter. Extended accredited ISO/IEC 17025 calibration certificates optionally available
Approvals	<ul style="list-style-type: none"> <li>EN 1434 and OIML R 75 Class 2 (PTB approval based on EN1434)</li> <li>MID class 2 approval and certification</li> </ul>

#### Type-dependent settings

Flow value	Predefined according to EN 1434 / OIML R 75 / MID
Approval	Country specific
Flow rate v <sub>f</sub>	0.02 ... 9 m/s (0.065 ... 29.5 ft/s)
Output A	Preset: Forward pulses
Output B	Preset: Alarm
Pulse value A & B (depending on DN value)	Preset: See scheme - previous page Preset for SITRANS FUE950 or free selectable depending on flow rate (Q <sub>s</sub> )
Pulse width	Preset: 5 ms
Flow unit setup	Preset: m <sup>3</sup> /h
Volume unit setup	Preset: m <sup>3</sup>

#### SITRANS FUE380 uncertainty

To ensure continuous accurate measurement, flowmeters must be calibrated. The calibration is conducted at Siemens flow facilities accredited according to ISO/IEC 17025 by DANAK or UKAS.

The accreditation bodies DANAK and UKAS have signed the ILAC MRA agreement (International Laboratory Accreditation Corporation - Mutual Recognition Arrangement). Therefore the accreditation ensures international traceability and recognition of the test results in 39 countries worldwide, including the US (NIST traceability).

A standard calibration certificate with Q<sub>n</sub> as selected flow is shipped with each SITRANS FUS380. This production calibration protocol consists of 2 x 3 points at Q<sub>i</sub>, 10% Q<sub>p</sub> and Q<sub>p</sub> (max. 4 200 m<sup>3</sup>/h).

#### Typical accuracy SITRANS FUE380:

±(0.5 + 0.02 Q<sub>p</sub>/Q) [%]

Q<sub>p</sub> according to EN 1434/OIML requirements.

Example: DN 100, Q<sub>p</sub> = 60 m<sup>3</sup>/h at Q = 1.2 m<sup>3</sup>/h.  
Accuracy at 1.2 m<sup>3</sup>/h = typical 1.5 %

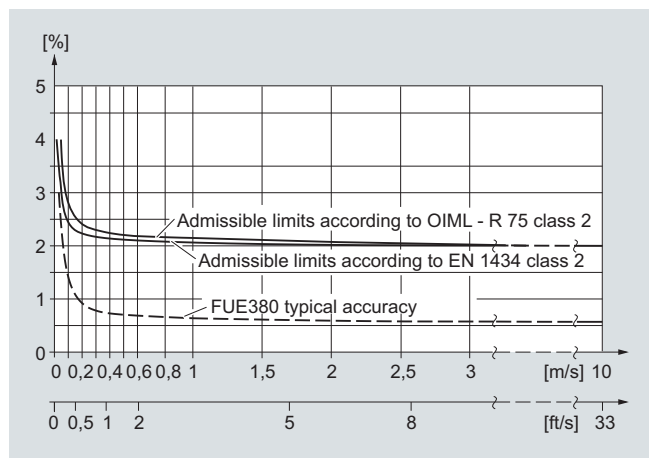

SITRANS FUE380 fulfils the requirements  
 $E_f = \pm (2 + 0.02 Q_p/Q_i)$  max.  $\pm 5\%$ , according to EN 1434 and OIML R 75, class 2 or MID class 2 requirements.

# Flow Measurement

## SITRANS F US Inline

### Flowmeter FUE380 with approval

Selection and Ordering data			Order No.	Order code
<b>Flowmeter SITRANS FUE380 (type-approved)</b>			<b>7ME 3 4 1 0 -</b>	
<b>Diameter</b>	<b>Flow setting [m<sup>3</sup>/h] Qp[m<sup>3</sup>/h]<sup>1)</sup> Qs [m<sup>3</sup>/h]</b>			
DN 50 (2") <sup>2)</sup>	15 <sup>3)</sup>	30	<b>1 B</b>	
DN 50 (2") <sup>2)</sup>	15 <sup>3)</sup>	45	<b>1 C</b>	
DN 50 (2") <sup>2)</sup>	30 <sup>4)</sup>	45	<b>1 D</b>	
DN 65 (2½") <sup>2)</sup>	25 <sup>3)</sup>	50	<b>1 F</b>	
DN 65 (2½") <sup>2)</sup>	25 <sup>3)</sup>	72	<b>1 G</b>	
DN 65 (2½") <sup>2)</sup>	50 <sup>4)</sup>	72	<b>1 H</b>	
DN 80 (3") <sup>2)</sup>	40 <sup>3)</sup>	80	<b>1 K</b>	
DN 80 (3") <sup>2)</sup>	40 <sup>3)</sup>	120	<b>1 L</b>	
DN 80 (3") <sup>2)</sup>	80 <sup>4)</sup>	120	<b>1 M</b>	
DN 100 (4")	60 <sup>3)</sup>	120	<b>1 P</b>	
DN 100 (4")	60 <sup>3)</sup>	180	<b>1 Q</b>	
DN 100 (4")	120 <sup>4)</sup>	180	<b>1 R</b>	
DN 125 (5")	100 <sup>3)</sup>	200	<b>1 T</b>	
DN 125 (5")	100 <sup>3)</sup>	280	<b>1 U</b>	
DN 125 (5")	200 <sup>4)</sup>	280	<b>1 V</b>	
DN 150 (6")	150 <sup>3)</sup>	300	<b>2 B</b>	
DN 150 (6")	150 <sup>3)</sup>	420	<b>2 C</b>	
DN 150 (6")	300 <sup>4)</sup>	420	<b>2 D</b>	
DN 200 (8")	250 <sup>3)</sup>	500	<b>2 F</b>	
DN 200 (8")	250 <sup>3)</sup>	700	<b>2 G</b>	
DN 200 (8")	500 <sup>4)</sup>	700	<b>2 H</b>	
DN 250 (10")	400 <sup>3)</sup>	800	<b>2 K</b>	
DN 250 (10")	400 <sup>3)</sup>	1120	<b>2 L</b>	
DN 250 (10")	800 <sup>4)</sup>	1120	<b>2 M</b>	
DN 300 (12")	560 <sup>3)</sup>	1120	<b>2 P</b>	
DN 300 (12")	560 <sup>3)</sup>	1560	<b>2 Q</b>	
DN 300 (12")	1120 <sup>4)</sup>	1560	<b>2 R</b>	
DN 350 (14")	750 <sup>3)</sup>	1500	<b>2 T</b>	
DN 350 (14")	750 <sup>3)</sup>	2100	<b>2 U</b>	
DN 350 (14")	1500 <sup>4)</sup>	2100	<b>2 V</b>	
DN 400 (16")	950 <sup>3)</sup>	1900	<b>3 B</b>	
DN 400 (16")	950 <sup>3)</sup>	2660	<b>3 C</b>	
DN 400 (16")	1900 <sup>4)</sup>	2660	<b>3 D</b>	
DN 500 (20")	1475 <sup>3)</sup>	2950	<b>3 K</b>	
DN 500 (20")	1475 <sup>3)</sup>	4130	<b>3 L</b>	
DN 500 (20")	2950 <sup>4)</sup>	4130	<b>3 M</b>	
DN 600 (24")	2150 <sup>3)</sup>	4300	<b>3 T</b>	
DN 600 (24")	2150 <sup>3)</sup>	6020	<b>3 U</b>	
DN 600 (24")	4300 <sup>4)</sup>	6020	<b>3 V</b>	
DN 700 (28")	2900 <sup>3)</sup>	5800	<b>4 F</b>	
DN 700 (28")	2900 <sup>3)</sup>	8120	<b>4 G</b>	
DN 700 (28")	5800 <sup>4)</sup>	8120	<b>4 H</b>	
DN 800 (32")	3800 <sup>3)</sup>	7600	<b>4 P</b>	
DN 800 (32")	3800 <sup>3)</sup>	10 640	<b>4 Q</b>	
DN 800 (32")	7600 <sup>4)</sup>	10 640	<b>4 R</b>	
DN 900 (36")	5000 <sup>3)</sup>	10 000	<b>5 B</b>	
DN 900 (36")	5000 <sup>3)</sup>	14 000	<b>5 C</b>	
DN 900 (36")	10 000 <sup>4)</sup>	14 000	<b>5 D</b>	
DN 1000 (40")	6000 <sup>3)</sup>	12 000	<b>5 K</b>	
DN 1000 (40")	6000 <sup>3)</sup>	16 800	<b>5 L</b>	
DN 1000 (40")	12 000 <sup>4)</sup>	16 800	<b>5 M</b>	
DN 1200 (48")	9000 <sup>3)</sup>	18 000	<b>5 T</b>	
DN 1200 (48")	9000 <sup>3)</sup>	25 200	<b>5 U</b>	
DN 1200 (48")	18 000 <sup>4)</sup>	25 200	<b>5 V</b>	

This device is shipped with a Quick Start guide and the SITRANS F manual CD containing the complete manual library. Printed Operating Instructions are available for purchase via PMD.

For notes 1) to 8) see next page

Selection and Ordering data		Order No.	Order code
<b>Flowmeter SITRANS FUE380 (type-approved)</b>		<b>7ME 3 4 1 0 -</b>	
<b>Flange norm and pressure rating</b>			
System without sensor - only a transmitter			
<u>EN 1092-1</u>			
PN 16 (DN 100 ... DN 1200)		<b>C</b>	
PN 25 (DN 200 ... DN 1000)		<b>D</b>	
PN 40 (DN 50 ... DN 250) <sup>5)</sup>		<b>E</b>	
<b>Compact / remote connection</b>			
Compact version, max. 120 °C (248 °F)			<b>0</b>
<u>Remote version, max. 200 °C (392 °F)</u>			
5 m (16.4 ft)			<b>2</b>
10 m (32.8 ft)			<b>3</b>
20 m (65.6 ft)			<b>4</b>
30 m (98.4 ft)			<b>5</b>
<b>Approvals / pulse output</b>			
Without approval (neutral)			<b>0</b>
Selectable pulse output (following code can be 1 ... 9)			
With approval marks			<b>1</b>
Selectable pulse output (following code can be 1 ... 9)			
With approval marks and seal			<b>2</b>
Selectable pulse output (following code can be 1 ... 9)			
Without approval (neutral) Preset pulse output for FUE950 energy meter (following code must be 2 ... 6)			<b>3</b>
With approval marks			<b>4</b>
Preset pulse output for FUE950 energy meter (following code must be 2 ... 6, dimension depending )			
With approval marks and seal			<b>5</b>
Preset pulse output for FUE950 energy meter (following code must be 2 ... 6)			
<b>Pulse output value setup</b>			
0.1 l/p (option for DN 50 ... DN 65) with 5 ms			<b>1</b>
1 l/p (typical for DN 50 ... DN 65) with 5 ms			<b>2</b>
2.5 l/p (typical for DN 80 ... DN 125) with 5 ms			<b>3</b>
10 l/p (typical for DN 150 ... DN 250) with 5 ms			<b>4</b>
50 l/p (typical for DN 300 ... DN 400) with 5 ms			<b>5</b>
100 l/p (typical for DN 500 ... DN 1200) with 5 ms			<b>6</b>
<b>Optional pulse values</b>			
250 l/pulse			<b>7</b>
1 m <sup>3</sup> /pulse			<b>8</b>
0.25 l/pulse			<b>9</b>
0.5 l/pulse			<b>9</b>
5 l/pulse			<b>9</b>
25 l/pulse			<b>9</b>
500 l/pulse			<b>9</b>
2.5 m <sup>3</sup> /pulse			<b>9</b>
5 m <sup>3</sup> /pulse			<b>9</b>
10 m <sup>3</sup> /pulse			<b>9</b>
25 m <sup>3</sup> /pulse			<b>9</b>
50 m <sup>3</sup> /pulse			<b>9</b>
100 m <sup>3</sup> /pulse			<b>9</b>
250 m <sup>3</sup> /pulse			<b>9</b>
500 m <sup>3</sup> /pulse			<b>9</b>
1000 m <sup>3</sup> /pulse			<b>9</b>
			<b>N 0 A</b>
			<b>N 0 B</b>
			<b>N 0 C</b>
			<b>N 0 D</b>
			<b>N 0 E</b>
			<b>N 0 F</b>
			<b>N 0 G</b>
			<b>N 0 H</b>
			<b>N 0 J</b>
			<b>N 0 K</b>
			<b>N 0 L</b>
			<b>N 0 M</b>
			<b>N 0 N</b>
			<b>N 0 P</b>

# Flow Measurement SITRANS F US Inline

## Flowmeter FUE380 with approval

Selection and Ordering data	Order No.	Order code
<b>Flowmeter SITRANS FUE380 (type-approved)</b>	<b>7ME3410 -</b>	
<b>Transmitter SITRANS FUE080</b>		
IP67/NEMA 4X/6 115 ... 230 V AC		<b>B</b>
IP67/NEMA 4X/6 3.6 V battery version, incl. dual battery pack		<b>D</b>
IP67/NEMA 4X/6 115 ... 230 V AC, including 3.6 V single battery backup		<b>E</b>
IP67/NEMA 4X/6 3.6 V battery version (no battery pack included) <sup>6)</sup>		<b>G</b>
<b>Country / approval type <sup>7)</sup></b>		
Neutral, no approval mark		<b>A</b>
China		<b>C</b>
Denmark <sup>8)</sup> , EN 1434/OIML R 75		<b>E</b>
Finland <sup>8)</sup> , EN 1434/OIML R 75		<b>F</b>
Germany <sup>8)</sup> , EN 1434 (PTB approval, DN 80 ... DN 1200)		<b>G</b>
Russia, EN 1434/OIML R 75		<b>M</b>
Ukraine, EN1434/OIML R 75		<b>P</b>
MID-Approval, (EN 1434/OIML R 75), English		<b>R</b>
MID-Approval, (EN 1434/OIML R 75), German		<b>S</b>
MID-Approval, (EN 1434/OIML R 75), Polish		<b>T</b>
MID-Approval, (EN 1434/OIML R 75), French		<b>U</b>
<b>Pulse width setup</b>		
5 ms (standard)		<b>2</b>
10 ms		<b>3</b>
20 ms		<b>4</b>
50 ms		<b>5</b>
100 ms		<b>6</b>
200 ms		<b>7</b>
500 ms		<b>8</b>

<sup>1)</sup>  $Q_p$  ( $Q_n$ ) is the normal flow according to the approval requirements.  $Q_p$  and  $Q_s$  is shown on the system label.

<sup>2)</sup> Pipe material bronze brass

<sup>3)</sup> EN 1434 flow values. The minimum flow ( $Q_i$ ) should be checked in the PIA-selector or product master data base (PMD).

<sup>4)</sup> OIML R 75 flow values

<sup>5)</sup> PN 40 standard for DN 50 ... DN 80 die-cast bronze pipes

<sup>6)</sup> Lithium batteries are subject to special transportation regulations according to United Nations "Regulation of Dangerous Goods, UN 3090 and UN 3091". Special transport documentation is required to observe these regulations. This may influence both transport time and costs.

<sup>7)</sup> Other countries in progress

<sup>8)</sup> In Europe the MID approval is the standard, please use following selections.

Please also see [www.siemens.com/SITRANSFordering](http://www.siemens.com/SITRANSFordering) for practical examples of ordering.

Selection and Ordering data	Order code
<b>Additional information</b>	
Please add „-Z“ to Order No. and following add-on code(s) with plain text.	
<b>Calibration / certificate FUE380</b>	
Approval, verification and sealing as defined with the order number. See order code.	
Production calibration for DN 50 ... DN 1200 with $Q_n$ as selected in diameter Calibration protocol: 2 x 3 points, $Q_i$ , 10% $Q_p$ and $Q_p$ (max. 4200 m <sup>3</sup> /h).	<b>Included</b>
Accredited Siemens ISO/IEC 17025 calibration for DN 50 ... DN 200 with $Q_n$ as selected in diameter. Certificate: 2 x 3 points, $Q_i$ , 10% $Q_p$ and $Q_p$ (max. 250 m <sup>3</sup> /h).	<b>D20</b>
Accredited Siemens ISO/IEC 17025 calibration for DN 100 ... DN 500 with $Q_n$ as selected in diameter. Certificate: 2 x 3 points, $Q_i$ , 10% $Q_p$ and $Q_p$ (max. 1300 m <sup>3</sup> /h).	<b>D21</b>
Accredited Siemens ISO/IEC 17025 calibration, DN 300 ... DN 1200 with $Q_n$ as selected in diameter. Certificate: 2 x 3 points, $Q_i$ , 10% $Q_p$ and $Q_p$ (max. 4200 m <sup>3</sup> /h).	<b>D22</b>
Output B as reverse flow pulses. No calibration/verification.	<b>E21</b>
<b>Material certificate</b>	
EN 10204-3.1	<b>F10</b>
<b>Tag name plate</b>	
Stainless steel tag name plate, text length depends on font size: 8 mm up to 10 characters, 4 mm up to 20 characters, or 3 mm up to 30 characters (add plain text)	<b>Y17</b>
<b>Operating instructions for SITRANS FUE380 flowmeter</b>	Order No.
English	<b>A5E00730100</b>
German	<b>A5E00740611</b>
Spanish	<b>A5E00754188</b>
French	<b>A5E00754173</b>

This device is shipped with a Quick Start Guide and a CD containing further SITRANS F literature.

All literature is also available for free at:

<http://www.siemens.com/flowdocumentation>

### MLFB Ordering example

Customer requires a flowmeter for custody transfer:

- DN 250, PN 25, compact version (media temperature max. 120 °C), battery version.
- Type-approved according to MID (EN 1434), verified and sealed, type label in German.
- Material certificate and metal tag name plate.
- Pulse output for energymeter SITRANS FUE950.

### Ordering:

FUE380: **7ME3410-2LD05-4DS2-Z, F10, Y17**

Example of appropriate energy meter (see the following chapter):

Energy meter type: **7ME3470-3AA36-0DD2-Z, E02**



Please use online Product selector to get latest updates.

Product selector link:

[www.pia-selector.automation.siemens.com](http://www.pia-selector.automation.siemens.com)











# Flow Measurement

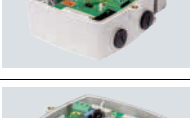

## SITRANS F US Inline

### Flowmeter FUS380 and FUE380

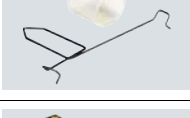
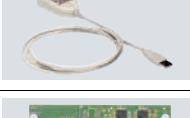
#### Accessories and spare parts for flowmeter FUS380 and FUE380

##### SITRANS FUS380/FUE380 - Spare parts

Description	Order No.	
Dual battery pack (6 year life-time) 33 Ah <sup>1)</sup>	<b>A5E02679676</b>	
Single battery back-up to main supply 13.5 Ah. Attention on note 1)	<b>A5E02679923</b>	
Battery cover for transmitter FUS080	<b>A5E00694468</b>	
PG 13.5 set (2 pcs.) for main cable/pulse cable	<b>FDK:083G0228</b>	
PG 13.5 set (2 pcs.) for dual coaxial cable (6 mm)	<b>A5E00694500</b>	
SITRANS FUS/FUE380 wall mounting kit for remote transmitter mounting, including connection plate (DN 50 ... DN 1200/2" ... 48")	<b>A5E00694509</b>	
SITRANS FUS/FUE380 terminal box for compact transmitter mounting, including connection plate, (bronze sensors only, DN 50 ... DN 80/2" ... 3")	<b>A5E01208138</b>	
SITRANS FUS/FUE380 terminal box for compact transmitter mounting, including connection plate, (steel sensors only, DN 100 ... DN 1200/4" ... 48")	<b>A5E00694660</b>	
Sun lid for FUS080 (Frame and lid)	<b>A5E02328485</b>	
Brace (holder) for optical IrDA eye	<b>A5E00695277</b>	
IrDA infrared interface adapter with USB for data acquisition with 1.2 m (3.9 ft) cable	<b>FDK:087L4163</b>	
RS 232 add-on module, point to point communication interface with Modbus RTU protocol	<b>FDK:087L4212</b>	
RS 485 add-on module, multi-drop communication interface with Modbus RTU protocol	<b>FDK:087L4213</b>	

Description	Order No.	
5 m (16.4 ft) cable set (4 pcs.) for DN 50 ... DN 80 (2" ... 3") remote mounting	<b>A5E01208092</b>	
10 m (32.8 ft) cable set (4 pcs.) for DN 50 ... DN 80 (2" ... 3") remote mounting	<b>A5E01208114</b>	
20 m (65.6 ft) cable set (4 pcs.) for DN 50 ... DN 80 (2" ... 3") remote mounting	<b>A5E01208117</b>	
30 m (98.4 ft) cable set (4 pcs.) for DN 50 ... DN 80 (2" ... 3") remote mounting	<b>A5E01208121</b>	
1 m (3.28 ft) cable set (4 pcs.) for DN 50 ... DN 80 (2" ... 3") for compact version	<b>A5E01208126</b>	
5 m (16.4 ft) cable set (4 pcs.) for DN 100 ... DN 1200 (4" ... 48") remote mounting	<b>A5E00695476</b>	
10 m (32.8 ft) cable set (4 pcs.) for DN 100 ... DN 1200 (4" ... 48") remote mounting	<b>A5E00695479</b>	
20 m (65.6 ft) cable set (4 pcs.) for DN 100 ... DN 1200 (4" ... 48") remote mounting	<b>A5E00695480</b>	
30 m (98.4 ft) cable set (4 pcs.) for DN 100 ... DN 1200 (4" ... 48") remote mounting	<b>A5E00695483</b>	
1 m (3.28 ft) cable set (4 pcs.) for DN 100 ... DN 1200 (4" ... 48") for compact version	<b>A5E00695486</b>	
<b>Process Device Manager SIMATIC PDM Single Point V6.0</b>	<b>6ES7658-3HX06-0YA5</b>	
For operation and parameterization of one field device, communication using PROFIBUS DP/PA or HART modem, incl. 1 TAG <b>Cannot</b> be expanded by further functions or TAG option/power-pack 5 languages (German, English, French, Spanish, Italian) executes with Windows 2000 Professional or Windows XP Professional		

<sup>1)</sup> Lithium batteries are subject to special transportation regulations according to United Nations "Regulation of Dangerous Goods, UN 3090 and UN 3091". Special transport documentation is required to observe these regulations. This may influence both transport time and costs.

Downloads for DEVICE description FUE380  
<http://support.automation.siemens.com/WWW/view/en/17320235>

## Dimensional drawings

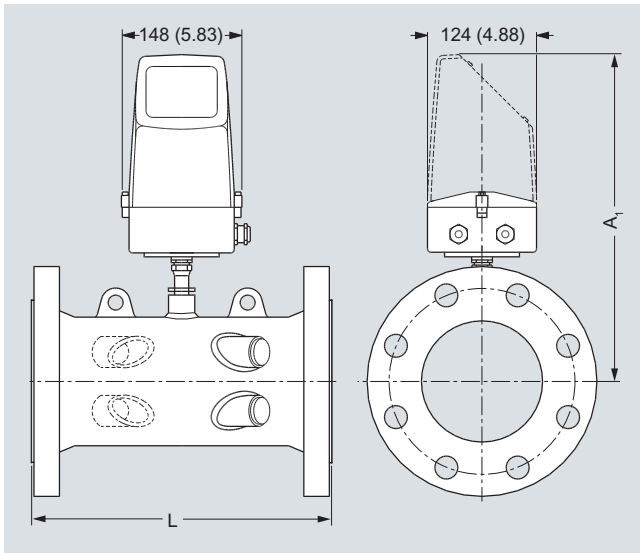

## Transmitter IP67/NEMA 4X/6, wall mounting

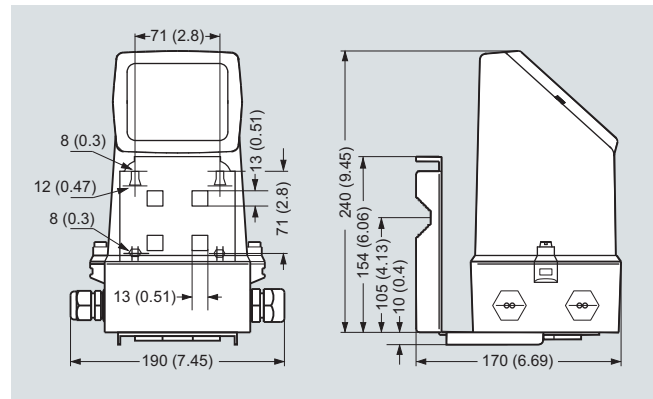

Dimensions in mm (inch)

## Pipe Dimensions for FUS380 and FUE380

Size DN	PN 16		PN 25		PN 40		A1 mm	Lift hug
	L mm	Weight kg	L mm	Weight kg	L mm	Weight kg		
50	-	-	-	-	300 +0/-2	10	350	No
65	-	-	-	-	300 +0/-2	15	360	No
80	-	-	-	-	350 +0/-3	18	370	No
100	350 +0/-2	15	-	-	350 +0/-3	18	375	No
125	350 +0/-2	18	-	-	350 +0/-3	24	380	No
150	500 +0/-3	28	-	-	500 +0/-3	34	390	No
200	500 +0/-3	38	500 +0/-3	47	500 +0/-3	55	414	No
250	600 +0/-3	60	600 +0/-3	76	600 +0/-3	91	440	No
300	500 +0/-3	66	500 +0/-3	81	-	-	466	Yes
350	550 +0/-3	94	550 +0/-3	121	-	-	495	Yes
400	600 +0/-3	124	600 +0/-3	153	-	-	507	Yes
500	625 +0/-3	176	625 +0/-3	235	-	-	558	Yes
600	750 +0/-3	244	750 +0/-3	292	-	-	609	Yes
700	875 +0/-3	258	875 +0/-3	416	-	-	660	Yes
800	1000 +0/-3	338	1000 +0/-3	562	-	-	710	Yes
900	1230 +6/-6	475	1300 +6/-6	835	-	-	810	No
1000	1300 +6/-6	594	1370 +6/-6	1078	-	-	910	No
1200	1360 +6/-6	860	-	-	-	-	1110	No

## Notes:

- Weight for transmitter/electronics 1.5 kg (3.3 lb)
- - Means not available
- All weights are **approximate**
- For flange values - see norm EN 1092-1



# Flow Measurement

## SITRANS F US Inline

### Flowmeter FUS380 and FUE380

Size inch	PN 16		PN 25		PN 40		A1 inch	Lift hug
	L inch	Weight lb	L inch	Weight lb	L inch	Weight lb		
2	-	-	-	-	12 +0/-0.08	22	14	No
2½	-	-	-	-	12 +0/-0.08	33	14.4	No
3	-	-	-	-	14 +0/-0.08	40	14.8	No
4	13.77 +0/-0.08	33	-	-	13.77 +0/-0.12	40	15	No
5	13.77 +0/-0.08	40	-	-	13.77 +0/-0.12	53	15.2	No
6	19.68 +0/-0.12	62	-	-	19.68 +0/-0.12	75	15.6	Yes
8	19.68 +0/-0.12	84	19.68 +0/-0.12	104	19.68 +0/-0.12	121	16.30	Yes
10	23.62 +0/-0.12	132	23.62 +0/-0.12	168	23.62 +0/-0.12	201	17.32	Yes
12	19.68 +0/-0.12	146	19.68 +0/-0.12	179	-	-	18.35	Yes
14	21.65 +0/-0.12	207	21.65 +0/-0.12	267	-	-	19.8	Yes
16	23.62 +0/-0.12	273	23.62 +0/-0.12	337	-	-	19.96	Yes
20	24.61 +0/-0.12	419	24.61 +0/-0.12	538	-	-	21.97	Yes
24	29.53 +0/-0.12	668	29.53 +0/-0.12	805	-	-	23.98	Yes
28	34.45 +0/-0.12	796	34.45 +0/-0.12	1217	-	-	25.98	Yes
32	39.37 +0/-0.12	1089	39.37 +0/-0.12	1698	-	-	27.95	Yes
36	39.2 +0/-0.24	1047	52.00 +0/-0.24	1841	-	-	32.4	No
40	52 +0/-0.24	1310	54.80 +0/-0.24	2376	-	-	36.4	No
48	54.4 +0/-0.24	1892	-	-	-	-	44.4	No

#### Notes:

- Weight for transmitter/electronics 1.5 kg (3.3 lb)
- - Means not available
- All weights are **approximate**
- For flange values - see norm EN 1092-1

**Schematics**

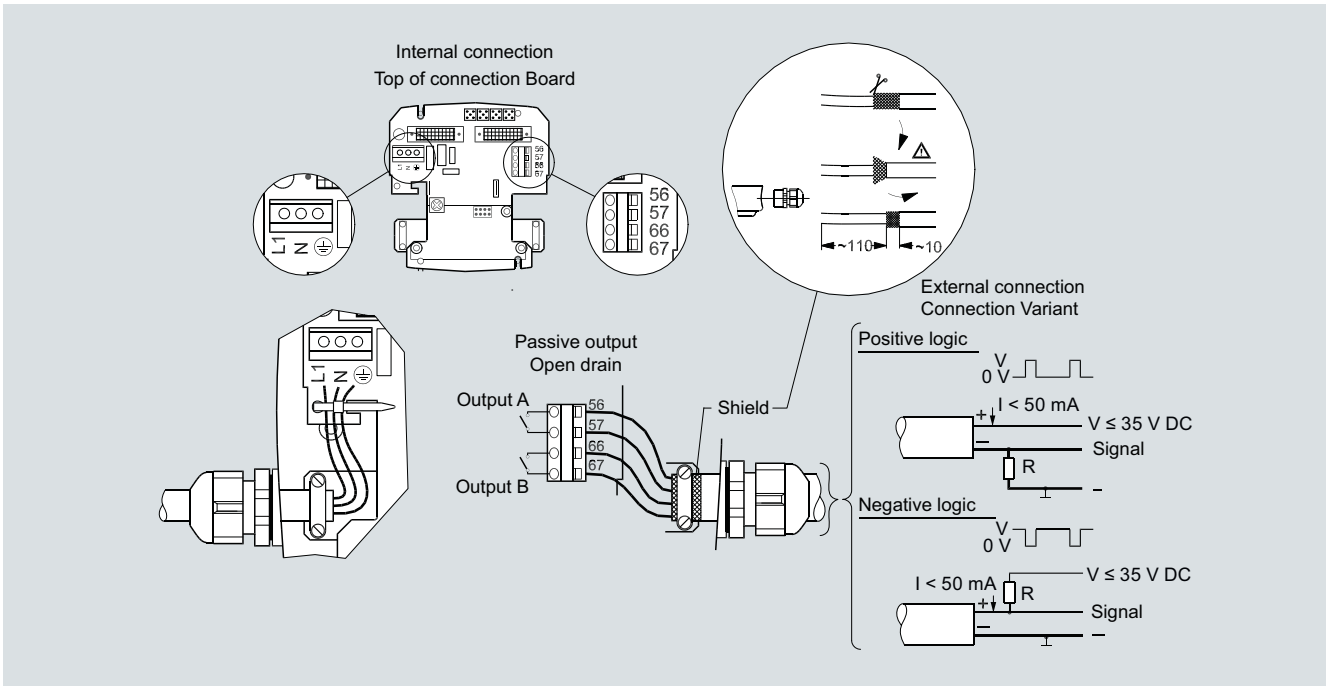

Electrical connection of transmitter SITRANS FUS/FUE380

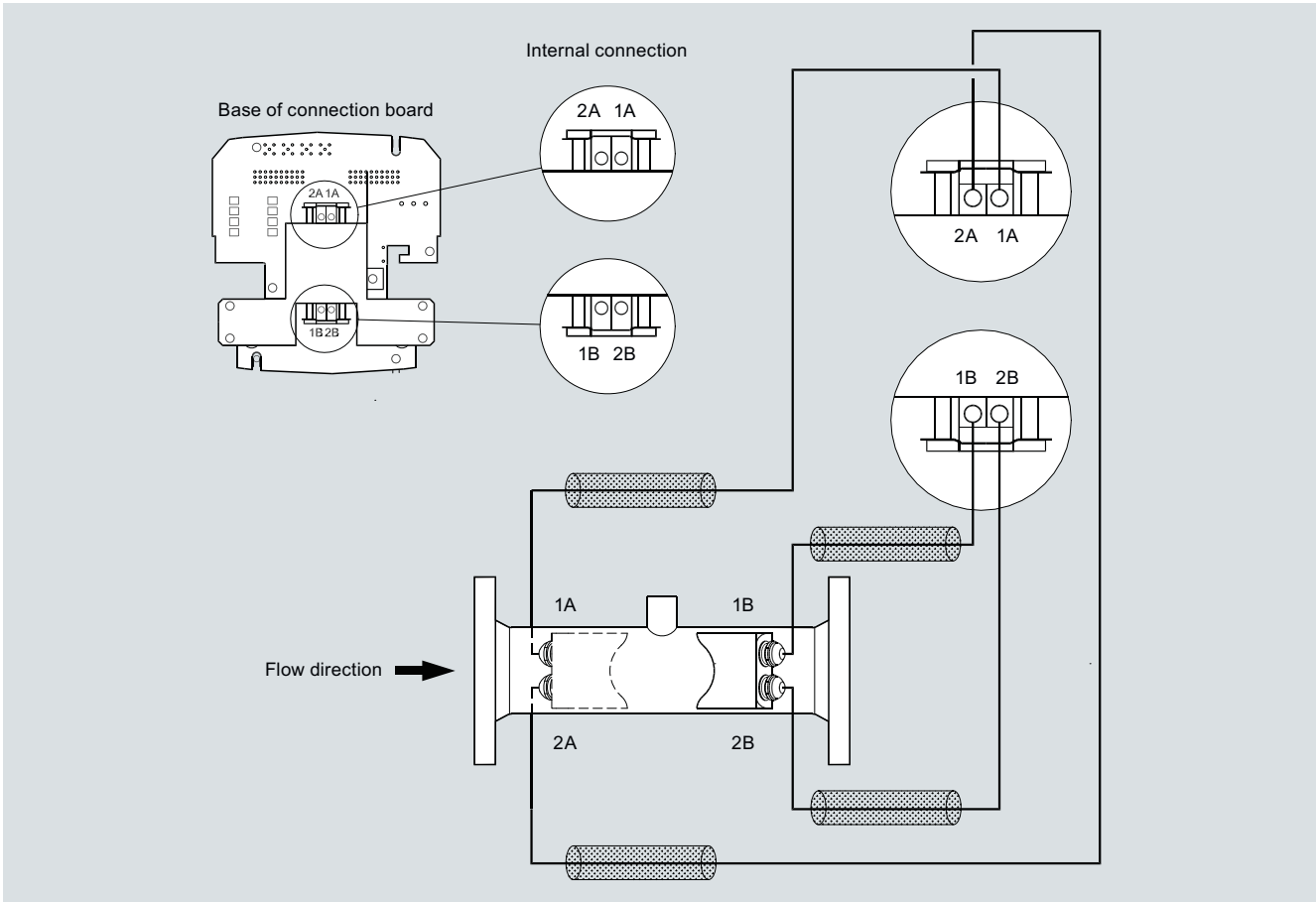

Electrical connection of sensor SITRANS FUS/FUE380

# FINE CONTROLS (UK) LTD

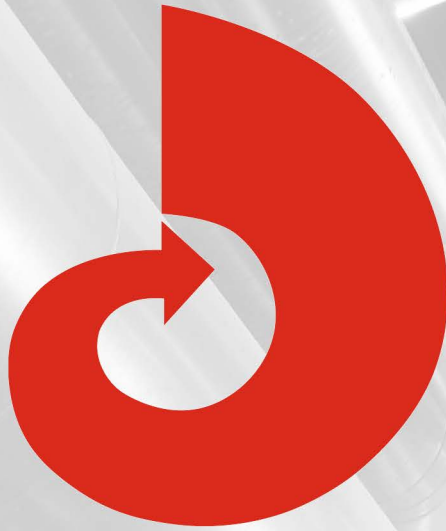

Fine Controls have been supplying process controls & instrumentation equipment since 1994, & now serves an ever expanding customer base, both in the UK & globally.

We offer a full range of valve & instrumentation products & services, with our product range representing leading technologies & brands:

**Flow:** Flow Meters & Transmitters, Flow Switches, Flow Control Valves & Batch Control Systems

**Temperature:** Temperature Probes & Thermowells, Temperature transmitters, Temperature Regulators & Temperature Displays

**Level:** Level Transmitters & Switches

**Pressure:** Pressure Gauges & Transmitters, Precision & High Pressure Regulators & I-P Converters, Volume boosters.

**Precision Pneumatics:** Pressure Regulators, I-P Converters, Volume Boosters, Vacuum Regulators

**Valves:** Solenoid & Pneumatic Valves, Control Valves & Positioners, Actuated Ball, Globe or Diaphragm Valves & Isolation Valves

**Services:** Repair, Calibration, Panel Build, System Design & Commissioning

A rotork® Brand  
**FAIRCHILD**



**bürkert**



**SIEMENS**



**alcon**  
SOLENOID VALVES

A rotork® Brand



**MIDLAND-ACS**  
A rotork® Brand



**Honeywell**



**Bourdon**  
Baumer Group



**SOLDO**  
CONTROLS

A rotork® Brand



Fine Controls (UK) LTD, Bassendale Road, Croft Business Park,  
Bromborough, Wirral, CH62 3QL UK  
Tel: 0151 343 9966  
Email: sales@finecontrols.com