

FINE CONTROLS (UK) LTD



Fine Controls have been supplying process controls & instrumentation equipment since 1994, & now serves an ever expanding customer base, both in the UK & globally.

We offer a full range of valve & instrumentation products & services, with our product range representing leading technologies & brands:

Flow: Flow Meters & Transmitters, Flow Switches, Flow Control Valves & Batch Control Systems

Temperature: Temperature Probes & Thermowells, Temperature transmitters, Temperature Regulators & Temperature Displays

Level: Level Transmitters & Switches

Pressure: Pressure Gauges & Transmitters, Precision & High Pressure Regulators & I-P Converters, Volume boosters.

Precision Pneumatics: Pressure Regulators, I-P Converters, Volume Boosters, Vacuum Regulators

Valves: Solenoid & Pneumatic Valves, Control Valves & Positioners, Actuated Ball, Globe or Diaphragm Valves & Isolation Valves

Services: Repair, Calibration, Panel Build, System Design & Commissioning

A rotork® Brand
FAIRCHILD



bürkert



SIEMENS



alcon
SOLENOID VALVES

A rotork® Brand



MIDLAND-ACS
A rotork® Brand



Honeywell



Bourdon
Baumer Group



SOLDO
CONTROLS

A rotork® Brand



Fine Controls (UK) LTD, Bassendale Road, Croft Business Park,
Bromborough, Wirral, CH62 3QL UK
Tel: 0151 343 9966
Email: sales@finecontrols.com

Ultrasonic level measuring device



- For level measurement up to 8 m
- 4...20 mA/HART - 2 wires
- Suitable for solids
- ATEX certification

Type 8177 can be combined with...

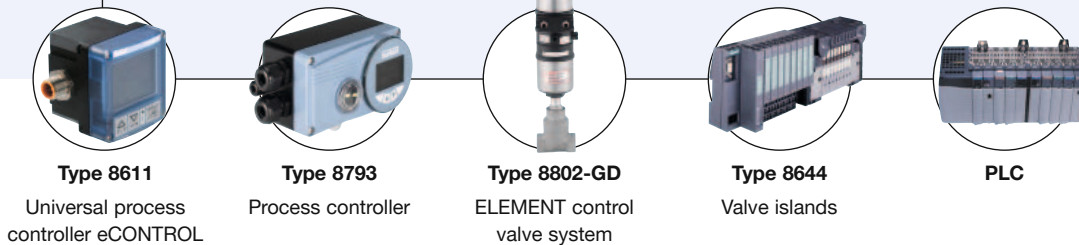

The Type 8177 is a non-contact ultrasonic level measuring device designed for continuous level measurement in open or closed vessels.

The unit is suitable for liquids, but also for solids, in virtually all industries, particularly in water and waste water management.

General data

Materials	
Housing	PBT, Stainless steel 316L (1.4404)
Cover	PC
Seal ring	EPDM
Ground terminal	Stainless steel 316Ti/316L (1.4571/1.4435)
Wetted parts	
Process connection, transducer	PVDF
Process seal	EPDM
Display	LCD in full dot matrix
Process connection	Thread G2" or NPT2"
Max. torque mounting boss	25 Nm
Electrical connection	Cable glands M20 x 1.5
Measuring value	Distance between lower edge of the transducer and product surface
Dead zone	0.4 m
Measuring range	0.4...8 m (for liquids) 0.4...3.5 m (for solids)
Process temperature	-40...+80°C (-40...176°F)
Vessel pressure	-0.2...2 bar (-2.9...29.02 PSI) (-20...200 kPa)
Vibration resistance	Mechanical vibrations with 4 g and 5...100 Hz
Temperature coefficient	0.06%/10K (Average temperature coefficient of the zero signal - temperature error)
Resolution	Max. 1 mm
Frequency	55 kHz
Interval	> 2 s (dependent on the parameter adjustment)
Beam angle at 3 dB	11°
Adjustment time¹⁾	> 3 s (dependent on the parameter adjustment)
Measurement deviation²⁾	< 0.2% or ± 4 mm (see diagram)

¹⁾ Time to output the correct level (with max. 10% deviation) after a sudden level change.
²⁾ = "measurement bias" as defined in the standard JCGM 200:2012

Measurement deviation diagram

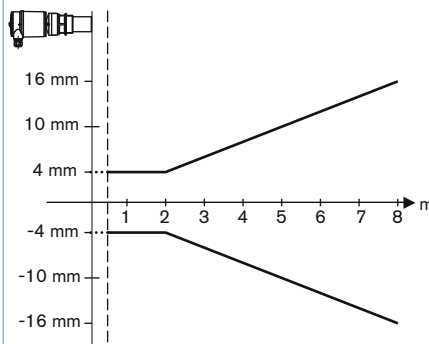

Electrical data	
Operating voltage	14...36 V DC or 14...30 V DC (Ex ia instrument)
Permissible residual ripple	< 100 Hz: $U_{ss} < 1$ V 100 Hz...10 kHz: $U_{ss} < 10$ mV
Output signal	4...20 mA/HART
Resolution	1.6 μ A
Fault signal	Current output unchanged; 20.5 mA; 22 mA < 3.6 mA (adjustable)
Current limitation	22 mA
Load	See load diagram
Damping (63% of the input variable)	0...999 s, adjustable
Environment	
Ambient temperature with display, adjustment elements	-20 ... +70°C (-4...+158°F) (operation and storage)
Relative humidity	Max. 75% (operation), max. 85% (storage); without condensation
Standards, directives and certifications	
Protection	IP66/IP67 with M20 x 1.5 gland mounted and tight- ened
Overvoltage category	III
Protection class	II
Standards and directives CE	The applied standards, which verify conformity with the EU Directives, can be found on the EU Type Ex- amination Certificate and/or the EU Declaration of conformity (if applicable)
NAMUR	NE 21; NE 43
Certification	ATEX ²⁾ : EN50014; EN50020; EN50284
Specifications Ex	
Ⓢ - Protection	Categories 1/2G or 2G
Ⓢ - Certification	EEx ia IIC T6
Conformity specifications ³⁾	
Operating voltage U_i	30 V
Short circuit rating I_i	131 mA
Power limitation P_i	983 mW
Ambient temperature	-20...+41°C (-4...+105.8°F) (dependent on categories)
Internal capacity C_i	negligible
Internal inductivity L_i	negligible

³⁾ homologation certificate PTB 07 ATEX 2003X

Load diagram

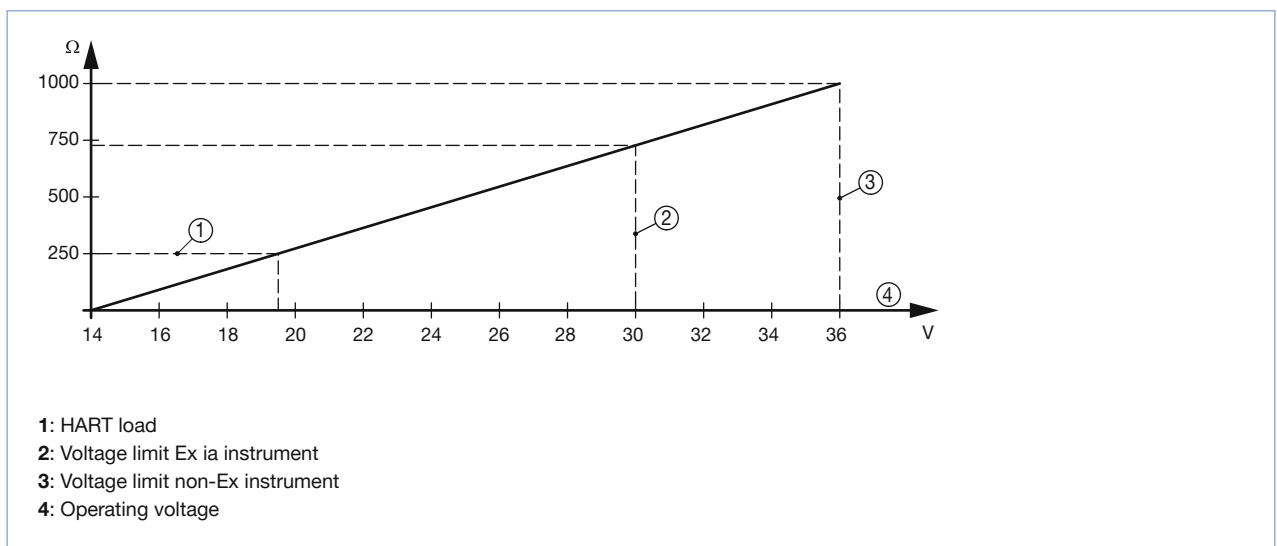

Target applications

■ Continuous level measuring for fluids and solids

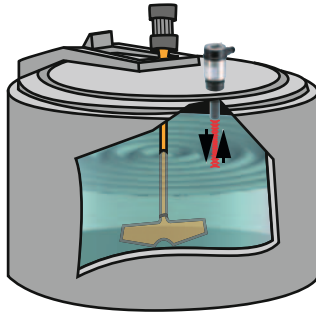

■ Open basins

A typical application for the 8177 ultrasonic measuring device is level measurement in open basins. Products such as rain water or sewage water, i.e. with impurities. Here is where the advantages of non-contact measurement with the 8177 come into their own: simple and maintenance-free. The degree of pollution of water or an accumulation of mud in the basin is not important, because the 8177 measures the surface.

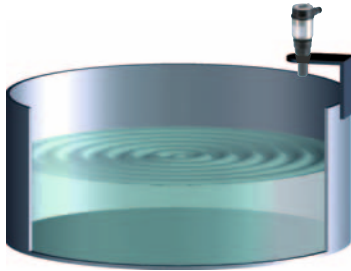

■ Distance measuring



■ Sludge container

In sewage treatment plants, the accumulated sludge is dewatered and transported via conveyor belts to containers. The 8177 measuring device measures the filling of the container. An empty container can thus be readied in good time before the max. level is reached.

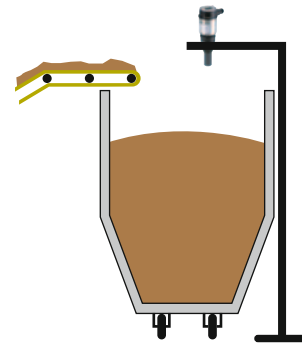

Principle of operation

The transducer of the ultrasonic measuring device emits short ultrasonic pulses, at 55 kHz to the measured product. These pulses are reflected by the medium surface and received by the transducer as echoes. The running time of the ultrasonic pulses from emission to reception is proportional to the distance and hence to the level. An integrated temperature sensor detects the temperature in the vessel and compensates the influence of temperature on the signal running time. The determined level is converted into an output signal and transmitted as a measured value.

The measuring device is adjusted with the display/configuration module. The entered parameters are generally saved in the measuring device Type 8177. Optionally, parameters may also be uploaded and downloaded with the display/configuration module.

▶ Set up with display/configuration module:

The display/configuration module can be inserted into the measuring device and removed again at any time. It is not necessary to interrupt the power supply. The measuring device is adjusted via the four keys of the display/configuration module.

Display/configuration module

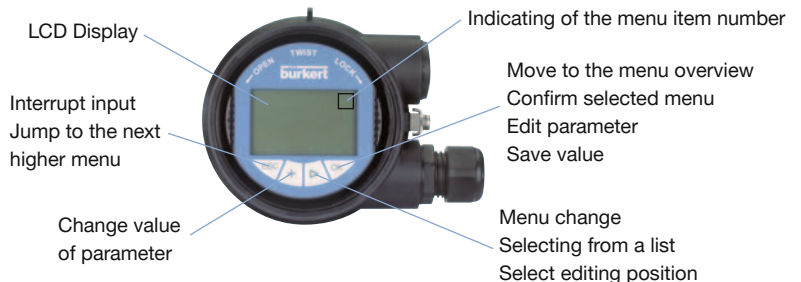

Dimensions [mm]

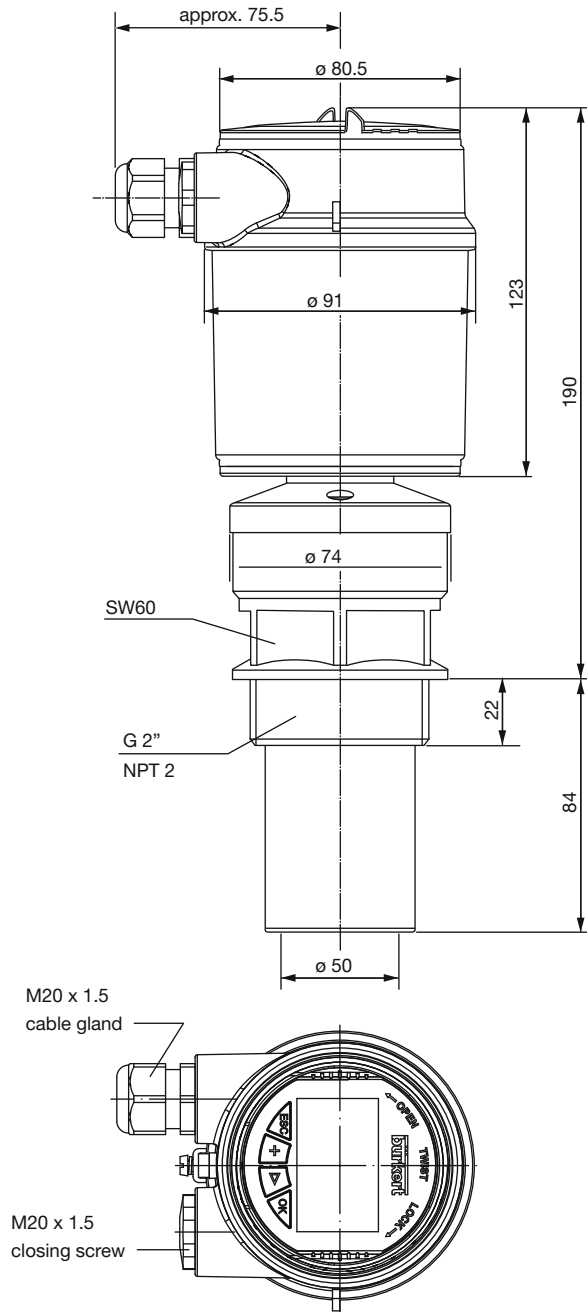

Ordering chart for compact measuring device Type 8177

Specification	Operating voltage	Output	Electrical connection	Item no. (with display / configuration module)	Item no. (without display / configuration module)
G2" mounting thread	14...36 V DC	4...20 mA/HART (2 wires)	Cable gland M20 x 1.5	558 224	559 243
NPT2" mounting thread	14...36 V DC	4...20 mA/HART (2 wires)	Cable gland M20 x 1.5	558 225	559 244
Ex version - ATEX certification G2" mounting thread	14...30 V DC	4...20 mA/HART (2 wires)	Cable gland M20 x 1.5	558 226	559 245

Ordering chart -accessories for measuring device Type 8177 (has to be ordered separately)

Specification	Item no.
Set with 2 reductions M20 x 1.5/NPT1/2" + 2 neoprene flat seals for cable gland + 2 screw-plugs M20 x 1.5	551 782
Set with a display/configuration module, a transparent cover and a seal ring	559 279
Set with a transparent cover and a seal ring	561 006

Interconnection possibilities with other Bürkert devices

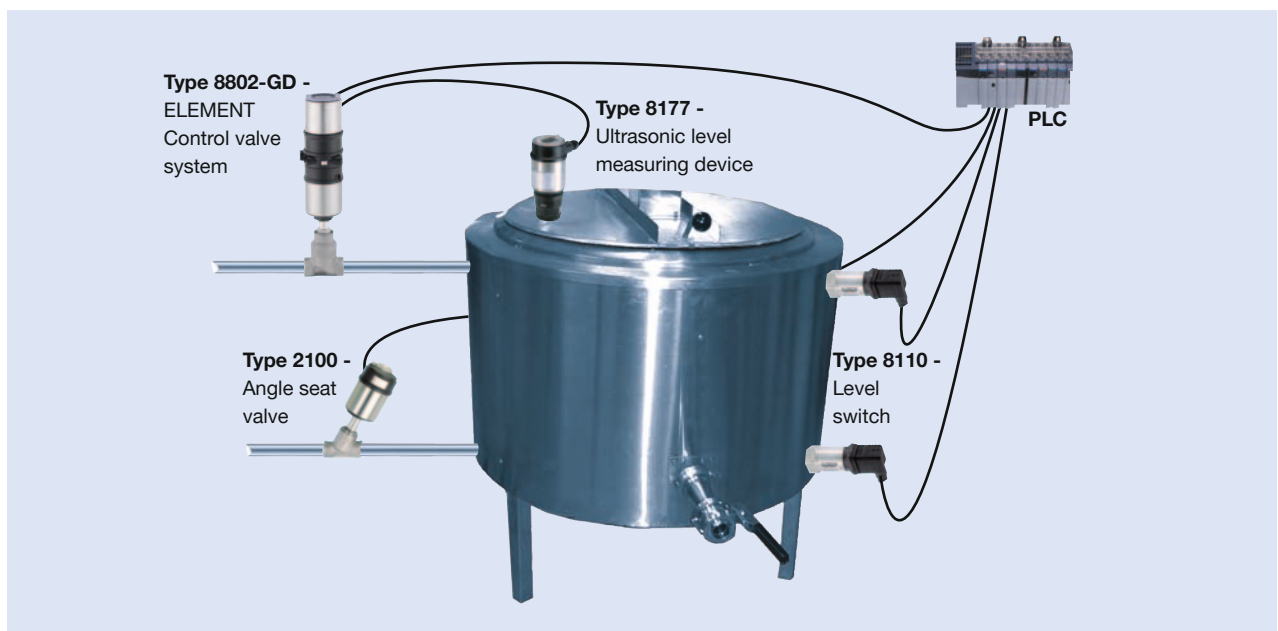

To find your nearest Bürkert facility, click on the orange box →

www.burkert.com

In case of special application conditions,
please consult for advice.

Subject to alteration.
© Christian Bürkert GmbH & Co. KG

1701/9_EU-en_00895005