

# FINE CONTROLS (UK) LTD



Fine Controls have been supplying process controls & instrumentation equipment since 1994, & now serves an ever expanding customer base, both in the UK & globally.

We offer a full range of valve & instrumentation products & services, with our product range representing leading technologies & brands:

**Flow:** Flow Meters & Transmitters, Flow Switches, Flow Control Valves & Batch Control Systems

**Temperature:** Temperature Probes & Thermowells, Temperature transmitters, Temperature Regulators & Temperature Displays

**Level:** Level Transmitters & Switches

**Pressure:** Pressure Gauges & Transmitters, Precision & High Pressure Regulators & I-P Converters, Volume boosters.

**Precision Pneumatics:** Pressure Regulators, I-P Converters, Volume Boosters, Vacuum Regulators

**Valves:** Solenoid & Pneumatic Valves, Control Valves & Positioners, Actuated Ball, Globe or Diaphragm Valves & Isolation Valves

**Services:** Repair, Calibration, Panel Build, System Design & Commissioning

A rotork® Brand  
**FAIRCHILD**



**bürkert**



**SIEMENS**



**alcon**  
SOLENOID VALVES

A rotork® Brand



**MIDLAND-ACS**  
A rotork® Brand



**Honeywell**



**Bourdon**  
Baumer Group



**SOLDO**  
CONTROLS

A rotork® Brand



Fine Controls (UK) LTD, Bassendale Road, Croft Business Park,  
Bromborough, Wirral, CH62 3QL UK  
Tel: 0151 343 9966  
Email: sales@finecontrols.com



## Flow sensor for water continuous measurement

- Ultrasonic flow meter using transit time method
- Dynamic range  $\geq 1:250$
- Low pressure drop
- No flow-settling section necessary in the inlet and/or outlet

Type 8081 can be combined with...



**Type 2712 (8630)**

Process control valve



**Type 8611**

PI Flow-Controller



**Type 8032**

Remote flow transmitter

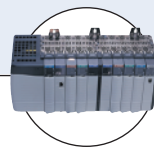

**PLC**

The Type 8081 ultrasonic flow sensor is intended for the measurement of water flows which may be slightly charged with contaminants. It consists of an electronic module and a brass fitting with a built-in measuring tube. It enables a control loop to be established. The electrical connection is made via an 5-pin M12 fixed connector.

The sensor features, depending on the version:

- a pulse output or
- a pulse output and a 4-20 mA current output.

Each version is available for 5 flow ranges:

- model QN 0.6 DN15: 0.06 to 20 l/min  
(nominal flow rate 0.6 m<sup>3</sup>/h namely 10 l/min)
- model QN 1.5 DN15: 0.1 to 50 l/min  
(nominal flow rate 1.5 m<sup>3</sup>/h namely 25 l/min)
- model QN 2.5 DN20: 0.16 to 82 l/min  
(nominal flow rate 2.5 m<sup>3</sup>/h namely 41 l/min)
- model QN 3.5 DN25: 0.6 to 116 l/min  
(nominal flow rate 3.5 m<sup>3</sup>/h namely 58 l/min)
- model QN 6.0 DN25: 1 to 200 l/min  
(nominal flow rate 6.0 m<sup>3</sup>/h namely 100 l/min)

### General data

<b>Process connection</b>	G or NPT External thread; 3/4", 1" or 1"1/4
<b>Materials</b>	
Housing, cover	PPS
Fixed connector M12	PA
Seal	Silicone
<b>Materials wetted parts</b>	
Fitting	Brass
Measuring tube	PES
Seal	EPDM
<b>Electrical connection</b>	5-pin M12 male fixed connector for female 5-pin M12 cable plug (not provided)
<b>Connection cable</b>	1.5 mm <sup>2</sup> max. cross-section

### Complete device data (fitting + electronic module)

<b>Pipe diameter</b>	DN 15 to 25
<b>Measuring range</b>	0.06 to 200 l/min
<b>Measuring element</b>	2 ultrasound emitter-receiver cells
<b>Medium temperature</b>	5 up to 90°C (41 to 194°F)
<b>Fluid pressure max.</b>	PN16 (232.16 PSI)
<b>Accuracy (Flowrate)</b>	≤ (0.01 % of F.S.* + 2% of measuring value) <sup>1)</sup>
<b>Repeatability</b>	≤ 1%

\* F.S. = Full scale (see flow range on accuracy diagram)

1) Under reference conditions i.e. measuring fluid = water, ambient and water temperature = 20°C (68°F).

Electrical data	
<b>Power supply (V+)</b>	12-36 V DC
<b>Current consumption</b>	Own consumption: < 4 mA Consumption with load: < 1 A
<b>Reversed polarity of DC</b>	Protected
<b>Voltage peak</b>	Protected
<b>Short circuit</b>	Protected for transistor output
<b>Output</b>	
Pulse (transistor) version without current output	NPN (as default setting) or PNP (on request), open collector, 700 mA max., 5 mA min., NPN output: 0.2-36 VDC
version with current output	PNP (as default setting) or NPN (on request), open collector, 700 mA max., 5 mA min., PNP output: supply voltage (V+)
Current	4-20 mA (sourcing mode and PNP transistor as default setting, sinking mode and NPN transistor on request) loop resistance max. : 1100 Ω at 36 V DC 610 Ω at 24 V DC; 100 Ω at 12 V DC
<b>Scaling</b> Pulse (Transistor)	K-factor: 500 Pulse/Litre (version QN 0.6 and 1.5) 200 Pulse/Litre (version QN 2.5 - 3.5) 100 Pulse/Litre (version QN 6.0)
Current	4 mA correspond to 0 l/min (by default) or to T <sub>min</sub> of temperature range (on request) 20 mA correspond to Q <sub>max.</sub> of flow range (by default) or to T <sub>max.</sub> of temperature range (on request)
Environment	
<b>Ambient temperature</b>	5 up to +55°C (41 to 131°F) (operating and storage)
<b>Relative humidity</b>	≤ 80%, without condensation
Standards, directives and approvals	
<b>Protection class</b>	IP65 with M12 cable plug plugged-in and tightened
<b>Standards, directives</b>	
EMC	EN 61000-6-3(2004), EN 61000-6-2(2005)
Pressure	Complying with article 3 of §3 from 97/23/CE directive.*
Vibration	EN 60068-2-6
Shock	EN 60068-2-27
<b>Approval / Certificate on request</b>	2.2 Certificate; Calibration Certificate

\* For the 97/23/CE pressure directive, the device can only be used under following conditions (depend on max. pressure, pipe diameter and fluid).

Type of fluid	Conditions
Fluid group 1, §1.3.a	Forbidden
Fluid group 2, §1.3.a	Allowed (PN*DN ≤1000)
Fluid group 1, §1.3.b	Forbidden
Fluid group 2, §1.3.b	Allowed

Accuracy diagram

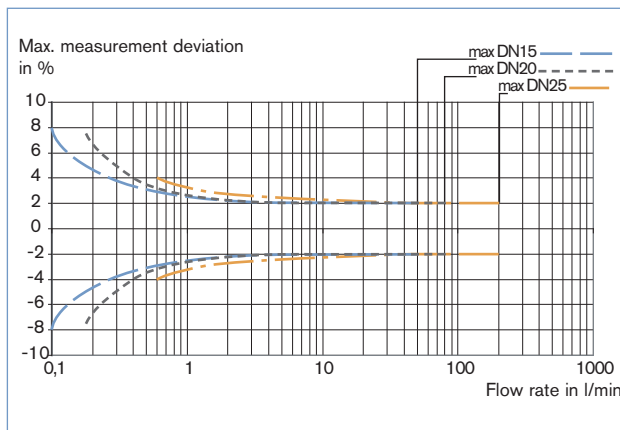

Design and principle of operation

The 8081 Ultrasonic flow meter is based on the transit time method. The sound transit time from emitter 1 to receiver 2 will be measured and compared with the transit time from emitter 2 to receiver 1. The difference in transit time is direct proportional to flow speed of the fluid.

The electronic module delivers a pulse signal proportional to the volume or an industry-standard 4-20mA signal, proportional to the flow rate or to the temperature.

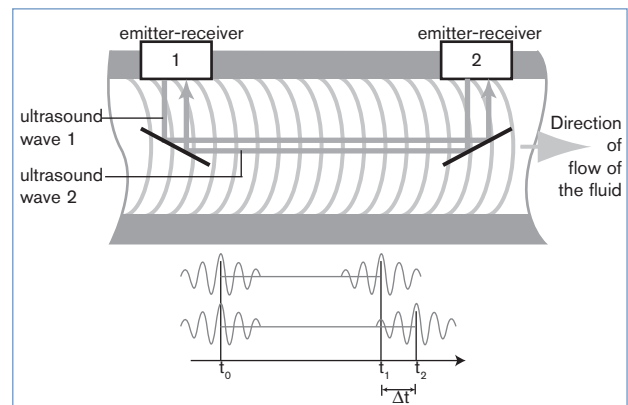

**Installation**

The 8081 ultrasound flow sensor can be fitted onto a horizontal or vertical pipe. When horizontally mounted, the max. fluid temperature is 90°C. But the max. fluid temperature must be reduced to 80°C when the electronic (black enclosure) is turned upwards. When vertically mounted the max. fluid temperature is also 80°C.

The correct direction of fluid flow in the pipe is indicated with an arrow, engraved on the underside of the fitting.

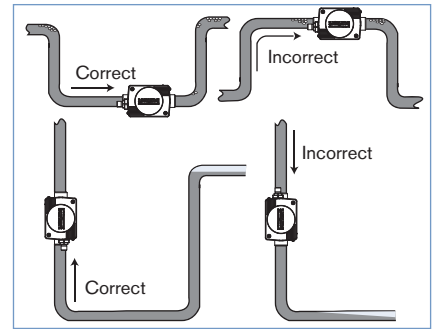
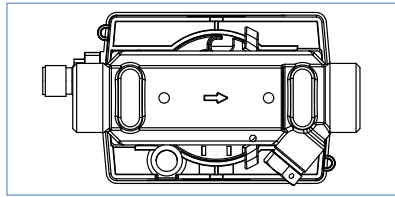

Minimum upstream and downstream distances are not necessary.

The 8081 works correctly when the pipe is full and free of any air bubbles near the sensor. In presence of bubbles in the pipe, the left installation no.1 should be avoided.

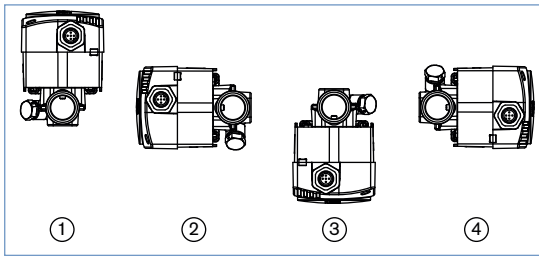

If the absence of any air bubbles cannot be guaranteed, the device should be fitted on a horizontal pipe, with the electronic enclosure facing down. This way, the bubbles will not interfere with the circulation of ultrasound waves.

It is equally advisable to place stop valves before and after the sensor, in order to facilitate the assembly and disassembly of the latter.

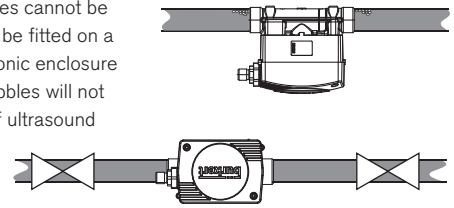

**Dimensions [mm]**

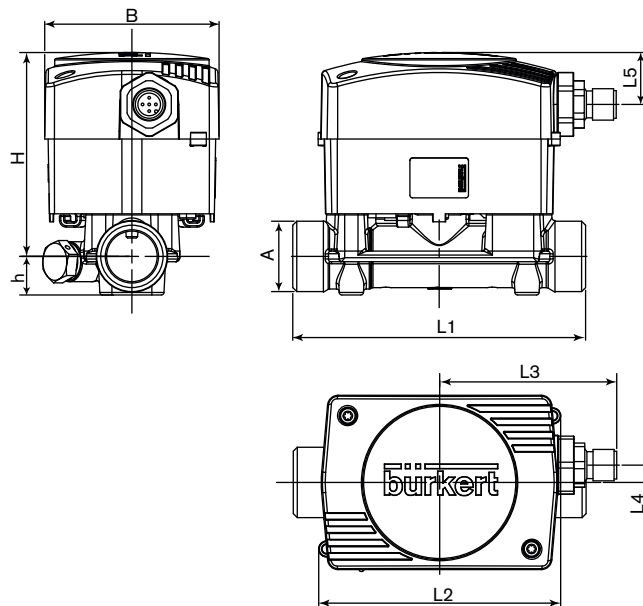

DN	A	B	H	h	L1	L2	L3	L4	L5
15	G or NPT 3/4"	65.5	83.5	23	110	90	58	6.5	19.5
20	G or NPT 1"	65.5	79.0	18	130	90	58	6.5	19.5
25	G or NPT 1 1/4"	65.5	76.5	14.5	260	90	58	6.5	19.5

## Ordering chart for sensor Type 8081

Model	DN	Flow range	Process connection	Outputs	Item no.
QN 0.6	15	0.06 à 20 l/min	External thread G 3/4"	Pulse, NPN	560 131
				Pulse, PNP + 4-20 mA as source	560 113
			External thread NPT 3/4"	Pulse, NPN	560 612
				Pulse, PNP + 4-20 mA as source	560 617
QN 1.5	15	0.1 up to 50 l/min	External thread G 3/4"	Pulse, NPN	559 865
				Pulse, PNP + 4-20 mA as source	559 868
			External thread NPT 3/4"	Pulse, NPN	560 613
				Pulse, PNP + 4-20 mA as source	560 618
QN 2.5	20	0.16 à 82 l/min	External thread G 1"	Pulse, NPN	559 866
				Pulse, PNP + 4-20 mA as source	559 869
			External thread NPT 1"	Pulse, NPN	560 614
				Pulse, PNP + 4-20 mA as source	560 619
QN 3.5	25	0.6 à 116 l/min	External thread G 1"1/4	Pulse, NPN	559 867
				Pulse, PNP + 4-20 mA as source	559 870
			External thread NPT 1"1/4	Pulse, NPN	560 615
				Pulse, PNP + 4-20 mA as source	560 620
QN 6.0	25	1 à 200 l/min	External thread G 1"1/4	Pulse, NPN	560 132
				Pulse, PNP + 4-20 mA as source	560 114
			External thread NPT 1"1/4	Pulse, NPN	560 616
				Pulse, PNP + 4-20 mA as source	560 621

## Ordering chart for accessories for sensor Type 8081 (to be ordered separately)

Description	Item no.
5 pin M 12 female cable plug moulded on cable (2 m, shielded)	438 680
5 pin M 12 female cable plug with plastic threaded locking ring	917 116

To find your nearest Bürkert facility, click on the orange box →

[www.burkert.com](http://www.burkert.com)In case of special application conditions,  
please consult for advice.Subject to alteration.  
© Christian Bürkert GmbH & Co. KG

0906/3\_EU-en\_00895047