

FINE CONTROLS (UK) LTD



Fine Controls have been supplying process controls & instrumentation equipment since 1994, & now serves an ever expanding customer base, both in the UK & globally.

We offer a full range of valve & instrumentation products & services, with our product range representing leading technologies & brands:

Flow: Flow Meters & Transmitters, Flow Switches, Flow Control Valves & Batch Control Systems

Temperature: Temperature Probes & Thermowells, Temperature transmitters, Temperature Regulators & Temperature Displays

Level: Level Transmitters & Switches

Pressure: Pressure Gauges & Transmitters, Precision & High Pressure Regulators & I-P Converters, Volume boosters.

Precision Pneumatics: Pressure Regulators, I-P Converters, Volume Boosters, Vacuum Regulators

Valves: Solenoid & Pneumatic Valves, Control Valves & Positioners, Actuated Ball, Globe or Diaphragm Valves & Isolation Valves

Services: Repair, Calibration, Panel Build, System Design & Commissioning

A rotork® Brand
FAIRCHILD



bürkert



SIEMENS



alcon
SOLENOID VALVES

A rotork® Brand



MIDLAND-ACS
A rotork® Brand



Honeywell



Bourdon
Baumer Group



SOLDO
CONTROLS

A rotork® Brand



Fine Controls (UK) LTD, Bassendale Road, Croft Business Park,
Bromborough, Wirral, CH62 3QL UK
Tel: 0151 343 9966
Email: sales@finecontrols.com

Digital flow transmitter for continuous flow measurement



- Compact or remote version for DN 06 to 400, PN10
- Shows both flow rate and volume (with two totalizers)
- Automatic-calibration: TEACH-IN
- Simulation: all output signals provided without the need for real flow

Type 8025 can be combined with...

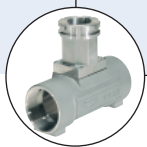

Type S020
INSERTION fitting



Type 8070
Positive displacement flow sensor



Type 8030
INLINE flow sensor



Type 2712 (8630)
Continuous TopControl system

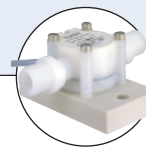

Type 8031
Flow sensor

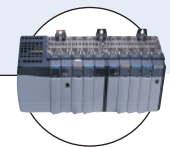

PLC

The flow transmitter is specially designed for use in neutral and slightly aggressive, solid-free liquids.

The device is available in different models:

- Compact transmitter with paddle-wheel sensor: standard signal output or battery powered indicator version.
- Remote universal transmitter for panel or wall mounting for connection to a flow sensor from the market; sensors with open collector output, relay reed output, TTL, CMOS or coil can be operated by this transmitter.
- Remote transmitter, for panel or wall mounting: standard signal output for connection to the Bürkert 8020 / 8030 sensor „Low Power“ version.

Technical data (common to the various versions)	
General data	
Display	15 x 60 mm, 8-digit LCD, alphanumeric, 15 segments, 9 mm high
Electrical connections	shielded cable with 1.5 mm ² max. cross-section
Environment	
Ambient temperature	0 up to +60°C (32 to 140°F) (operation and storage)
Relative humidity	≤ 80 %, without condensation
Standards and approvals	
Standard	EN 61000-6-2, EN 61000-6-3
EMC	EN 61010-1
Security	Complying with article 3 of §3 from 2006/95/CE directive.*
Pressure	EN 60068-2-6
Vibration	EN 60068-2-27
Shock	

* For the 2006/95/CE pressure directive, the device can only be used under following conditions (depend on max. pressure, pipe diameter and fluid).

Type of fluid	Conditions
Fluid group 1, §1.3.a	DN 25 only
Fluid group 2, §1.3.a	DN ≤ 32, or DN > 32 and PN*DN ≤ 1000
Fluid group 1, §1.3.b	PN*DN ≤ 2000
Fluid group 2, §1.3.b	DN ≤ 200

System versions

The compact version



combines a paddle-wheel flow sensor and an electronic module with a display in an IP65 enclosure.

The output signals are provided via a cable plug EN175301-803 or two cable glands.

Bürkert designed fitting ensures simple installation of the Bürkert sensor into pipes from DN 15 to DN 400.

The panel-mounted version



consists of an electronic module 8025 integrated in a front-cover. The associated separate flow sensor is an 8020, an 8030 with pulse signal, or another flow sensor available from Bürkert or the market.

The output signals are provided on a terminal strip.

The wall-mounted version



consists of an electronic module 8025 in an IP65 enclosure. The associated flow sensor is an 8020, an 8030 with pulse signal, or another flow sensor available from Bürkert or the market.

The output signals are provided on a terminal strip via cable glands.

Operation and display

The device can be calibrated by means of the K-factor, or via the TEACH-IN function. Customized adjustments, such as measuring range, engineering units, pulse output and filtering level are carried out on site.

The operation is specified according to two or three levels, depending on the transmitter version:

Flow transmitter (compact or remote)

▶ Indication in operating mode / Display

- flow rate
- output current
- main totalizer
- daily totalizer with reset function

▶ Parameter definition

- language
- engineering units
- K-factor / TEACH-IN function
- measuring range 4-20 mA
- pulse output
- relay (option)
- filter
- reset main totalizer

▶ Test

- alteration of basic adjustment (offset, span)
- frequency test of sensor
- flow simulation (dry-run test operation)

Battery indicator / totalizer (compact)

▶ Indication in operating mode / Display

- flow rate
- main totalizer
- daily totalizer with reset function

▶ Parameter definition

- language
- engineering units
- K-factor / TEACH-IN function
- filter
- reset main totalizer

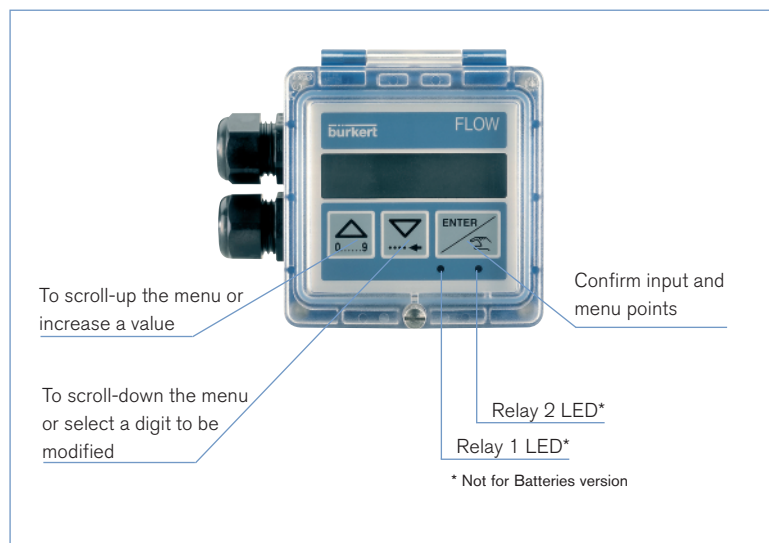

Compact transmitter

The compact transmitter

is available in two versions:

- standard signal (4-20 mA, frequency)
- battery indicator / totalizer



Accuracy diagram

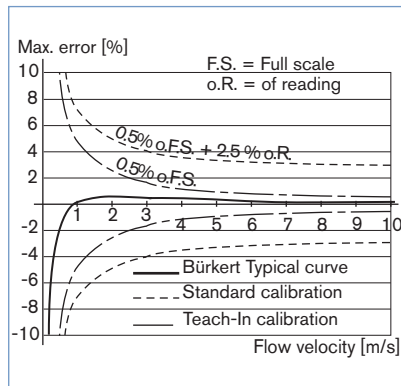

Design

When liquid flows through the pipe, the paddle-wheel with 4 inserted magnets is set in rotation, producing a measuring signal in the sensor (coil or Hall transducer).



The frequency modulated induced voltage is proportional to the flow velocity of the fluid.

A conversion coefficient (K-factor, available in the instruction manual of the fitting), specific to each pipe (size and material) enables the conversion of this frequency into flow rate.

The electronic component converts the measured signal into several outputs (according to the transmitter version) and displays the actual value.

General data																	
Compatibility	with fittings S020 (see corresp. data sheet)																
Materials	<table border="0"> <tr> <td>Housing, cover, lid, nut</td> <td>PC</td> </tr> <tr> <td>Front panel foil</td> <td>Polyester</td> </tr> <tr> <td>Screws</td> <td>Stainless steel</td> </tr> <tr> <td>Cable plug / glands</td> <td>PA</td> </tr> <tr> <td>Wetted parts materials</td> <td></td> </tr> <tr> <td> Fitting</td> <td>Brass, stainless steel 1.4435/316L, PVC, PP or PVDF</td> </tr> <tr> <td> Sensor finger, paddle-wheel</td> <td>PVDF</td> </tr> <tr> <td> Axis and bearing / Seal</td> <td>Ceramics / FKM (EPDM option)</td> </tr> </table>	Housing, cover, lid, nut	PC	Front panel foil	Polyester	Screws	Stainless steel	Cable plug / glands	PA	Wetted parts materials		Fitting	Brass, stainless steel 1.4435/316L, PVC, PP or PVDF	Sensor finger, paddle-wheel	PVDF	Axis and bearing / Seal	Ceramics / FKM (EPDM option)
Housing, cover, lid, nut	PC																
Front panel foil	Polyester																
Screws	Stainless steel																
Cable plug / glands	PA																
Wetted parts materials																	
Fitting	Brass, stainless steel 1.4435/316L, PVC, PP or PVDF																
Sensor finger, paddle-wheel	PVDF																
Axis and bearing / Seal	Ceramics / FKM (EPDM option)																
Electrical connections	Cable plug EN 175301-803 or cable glands M20 x 1.5 or none (for battery version).																

Complete device data (Fitting S030 + Electronics)	
Pipe diameter	DN 15 to 400
Measuring range	0.5 to 10 m/s (Battery version - Coil transducer) 0.3 to 10 m/s (Hall transducer version)
Fluid temperature with fitting in	
PVC	0 up to 50°C (32 to 122°F)
PP	0 up to 80°C (32 to 176°F)
PVDF, brass or stainless steel	-15 up to 80°C ¹⁾ (32 to 176°F)
Fluid pressure max.	PN10 (145.1 PSI) (see pressure/temperature diagram)
Viscosity / Particles rate	300 cSt. max. / 1% max.
Accuracy	
Teach-In	≤ ±0.5% of F.S.* (at 10 m/s) ²⁾
Standard K-factor	≤ ±(0.5% of F.S.* + 2.5% of Reading) ²⁾
Linearity	≤ ±0.5% of F.S.* (at 10 m/s) ²⁾
Repeatability	≤ 0.4% of Reading ²⁾

Electrical data	
Power supply	
Standard signal version	12-30 V DC (V+) ± 10%, filtered and regulated or 115/230 V AC 50/60 Hz (see technical specifications 115/230 VAC)
Battery indicator / totalizer version	2 x 9 V DC batteries, autonomy min. 1 years at 20°C (68°F)
Reversed polarity of DC	protected
Current consumption with sensor (without consumption of pulse output)	≤ 70 mA - transmitter with relays ≤ 20 mA - transmitter without relay
Output	
Standard signal version	
Signal current	4-20 mA (3-wire with relays; 2-wire without relay) max. loop impedance: 900 Ω at 30 V DC; 600 Ω at 24 V DC; 50 Ω at 12 V DC; 800 Ω with a 115/230 V AC voltage supply
Pulse	Polarized, potential free, 5...30 V DC; 100 mA, protected, line drop at 100 mA: 1.5 VDC
Relay	2 relays, freely programmable, 3A, 230 V AC
Battery indicator / totalizer version	None

Technical specifications 115/230 VAC	
Voltage supply available inside the device	27 V DC regulated, max. current: 125 mA integrated protection: fuse 125 mA temporised power: 3 VA

Standard	
Protection class	IP65 with cable plug or gland mounted and tightened or with obturator locked if not used.

¹⁾ with Battery version = 100°C (212°F)

²⁾ Under reference conditions i.e. measuring fluid=water, ambient and water temperature=20°C (68°F), applying the minimum inlet and outlet pipe straights, matched inside pipe dimensions.

* F.S.=Full scale (10 m/s)

Installation

The 8025 flow transmitter can easily be installed into any Bürkert INSERTION fitting system (S020) by just fixing the main nut. Minimum straight upstream and downstream distances must be observed. According to the pipe's design, necessary distances can be bigger or use a flow conditioner to obtain the best accuracy. For more information, please refer to EN ISO 5167-1.

EN ISO 5167-1 prescribes the straight inlet and outlet distances that must be complied with when installing fittings in pipe lines in order to achieve calm flow conditions. The most important layouts that could lead to turbulence in the flow are shown below, together with the associated prescribed minimum inlet and outlet distances. These ensure calm, problem-free measurement conditions at the measurement point.

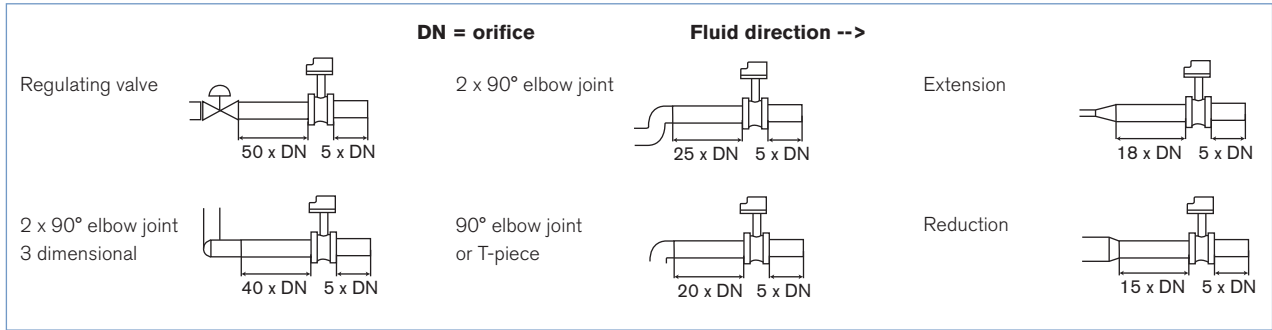

The flow rate transmitter can be installed into either horizontal or vertical pipes.

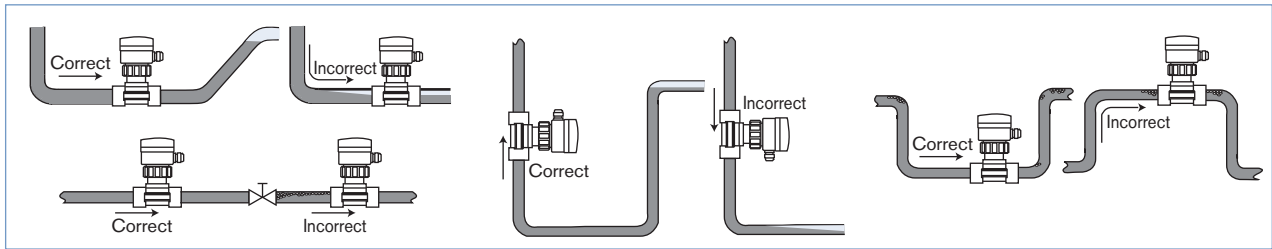

Pressure and temperature ratings must be respected according to the selected fitting material. The suitable pipe size is selected using the diagram Flow / Velocity / DN. The flow transmitter is not designed for gas flow measurement.

Pressure / Temperature diagram

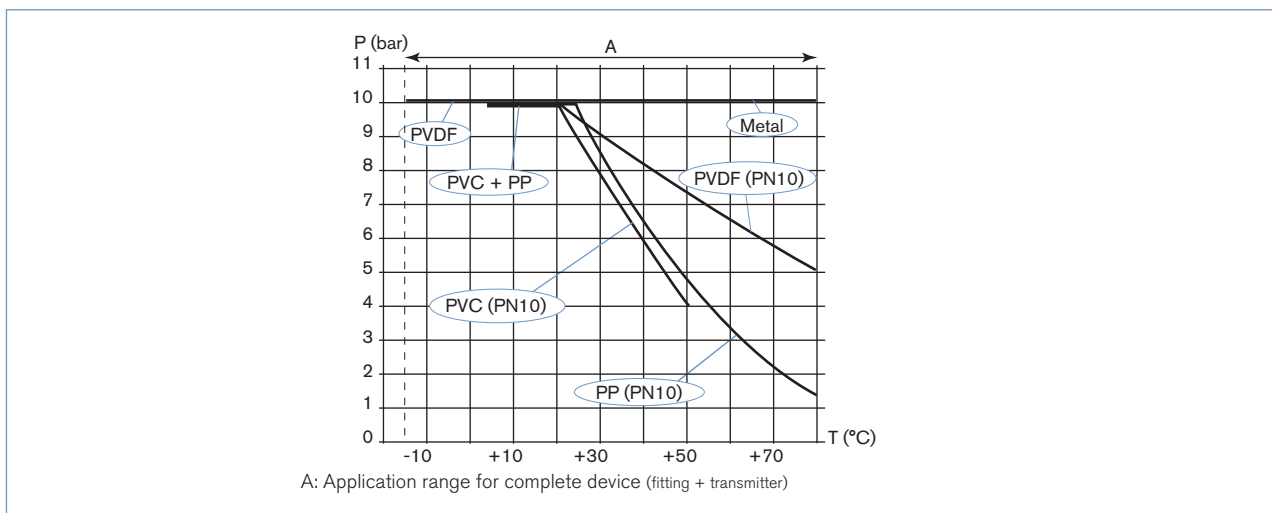

Selection of fitting / pipe size

Example:

- Specification of nominal flow: 10 m³/h
- Ideal flow velocity: 2...3 m/s

For these specifications, the diagram indicates a pipe size of DN40 [or DN50 for (*) mentioned fittings]

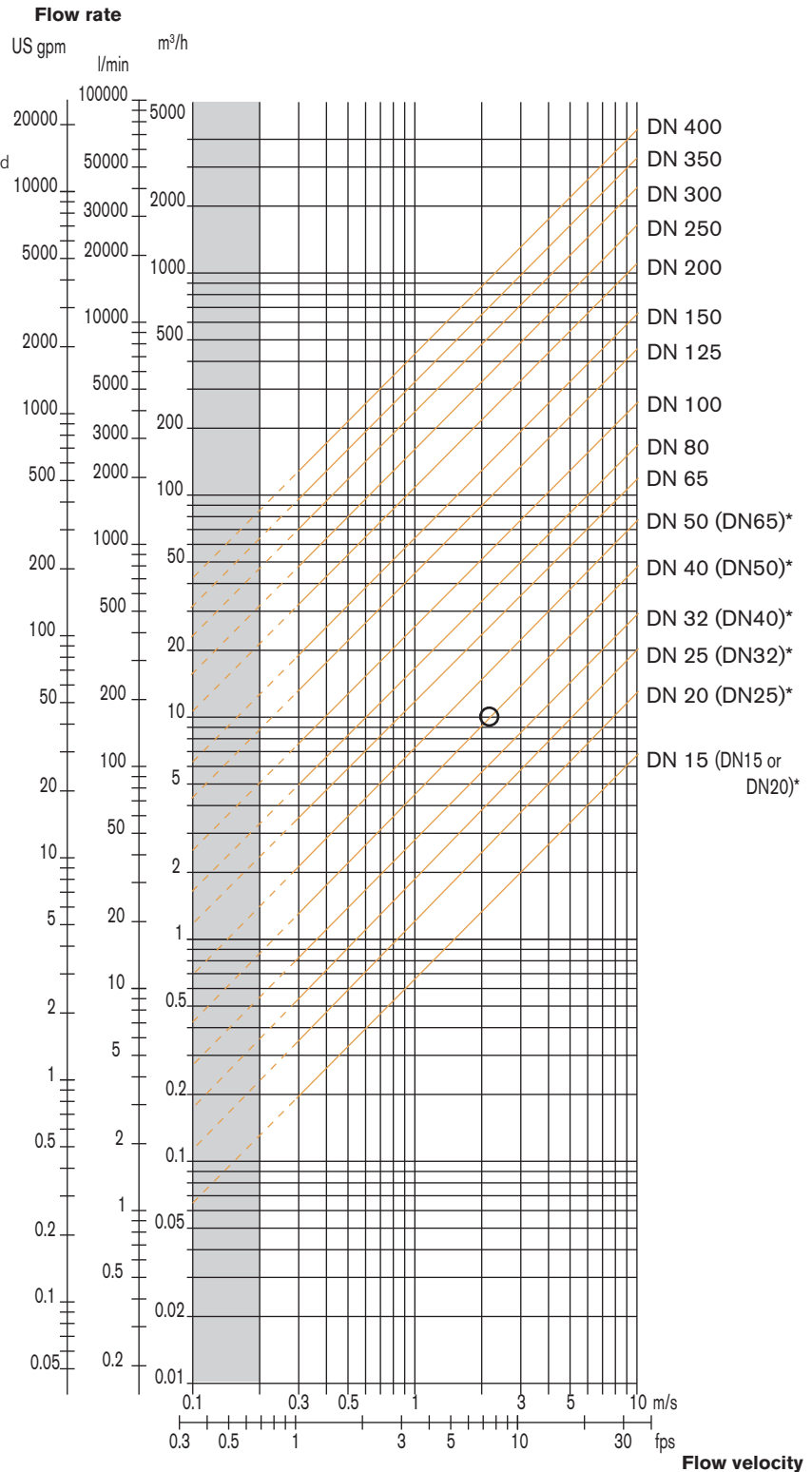

*** for following fittings:**

- with external threads acc. to SMS 1145
- with weld-ends acc. to SMS 3008, BS 4825 / ASME BPE or DIN 11850 Series 2
- Clamp acc. to SMS 3017 / ISO 2852, BS 4825 / ASME BPE or DIN 32676

Dimensions [mm]

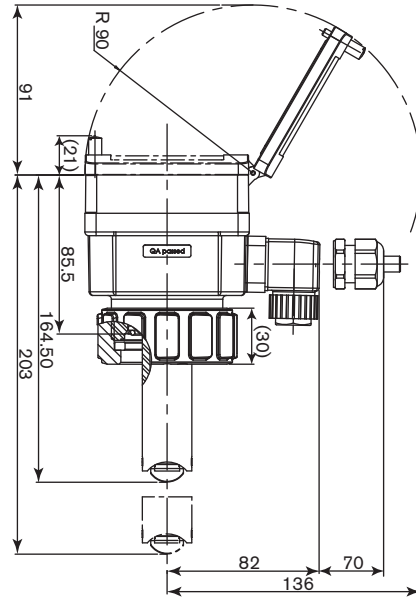

Note:

The length of the sensor finger depends on the fitting used.
See data sheet Type S020.

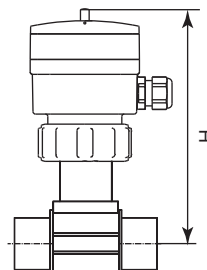
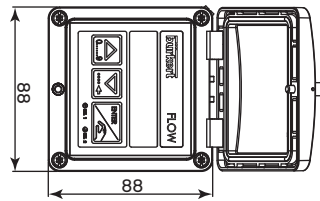

DN [mm]	H [mm]			
	T-Fitting	Saddle	Plastic spigot	St. St. spigot
15	187			
20	185			
25	185			
32	188			
40	192			
50	198	223		193
65	198	221	206	199
80		226	212	204
100		231	219	214
110		227		
125		234	254	225
150		244	261	236
180		268		
200		280	282	257
250			300	317
300			312	336
350			325	348
400			340	

Remote transmitter

The remote transmitter is available in two versions:

- 8025 Universal transmitter for connection to Bürkert sensor or other sensor types

This flow transmitter can be associated with Bürkert flow sensor 8020, 8030, 8070... or another flow sensor, with pulse output signal.

- 8025 transmitter for connection to compact Bürkert sensors.

This flow transmitter can only be associated with Bürkert flow sensor 8020, 8030 or 8070 with „Low Power“ pulse output signal.

Each transmitter is available in either:

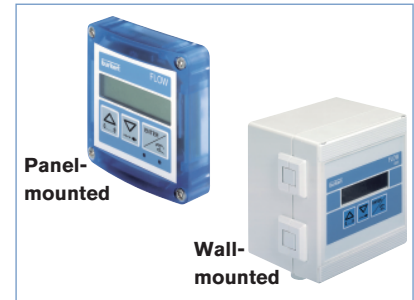

Dimensions [mm]

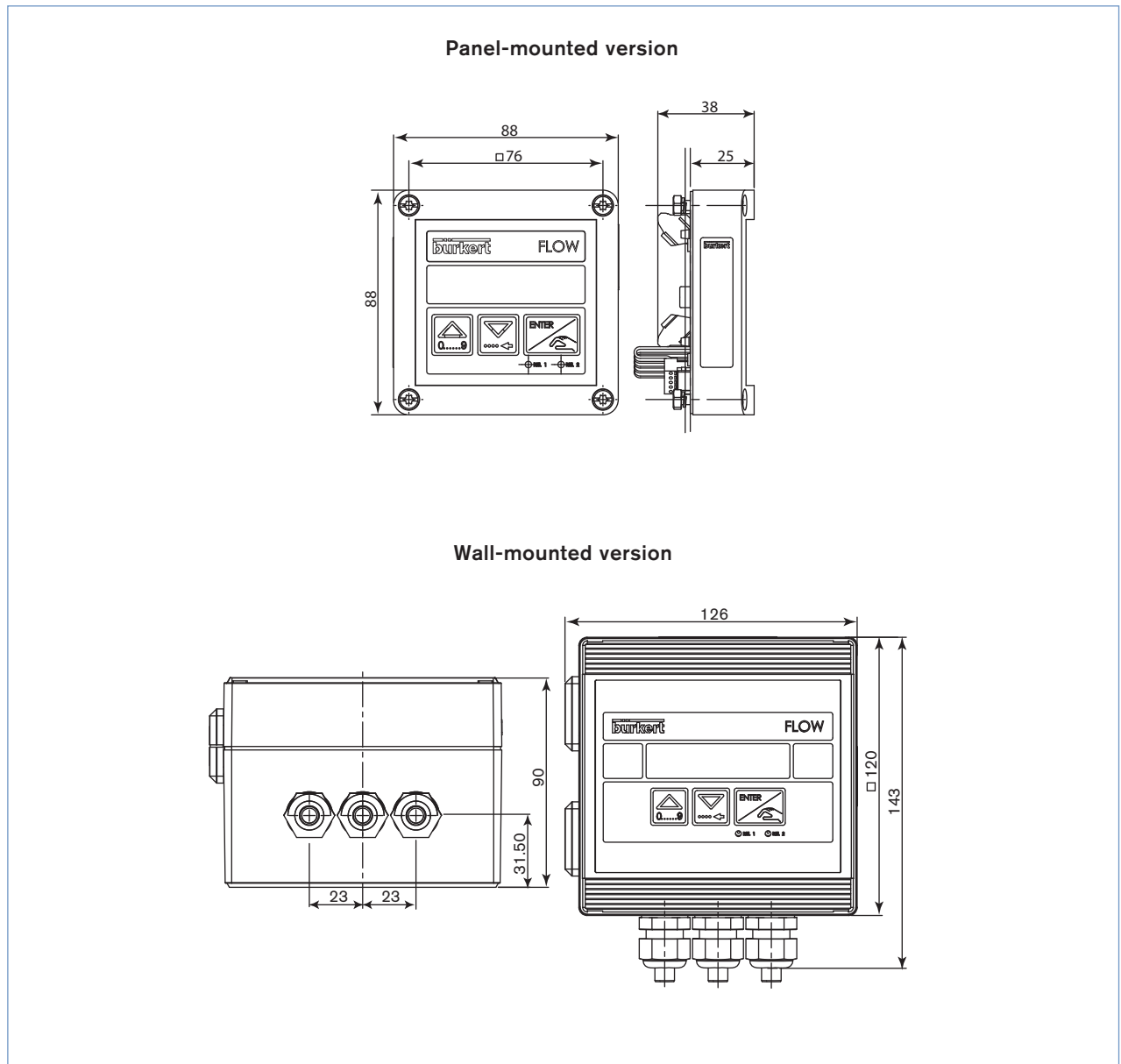

Technical data (remote version)

General data	8025 Universal transmitter	8025 transmitter
Compatibility	Bürkert flow sensor with frequency output (8020, 8030, 8030HT, 8041, 8031, 8070, 8071) and other sensors with compatible electrical data.	Bürkert flow sensor with frequency output 8020, 8030 or 8070 (pulse "Low Power" version).
Materials Housing, cover Front panel foil Screws Cable glands	PC (panel-mounted version); ABS (wall-mounted version) Polyester Stainless steel PA (wall-mounted version)	
Electrical connections	Terminals (panel-mounted version) or terminals via gland (wall-mounted version)	

Electrical data	Universal transmitter	8025 transmitter
Power supply Panel-mounted version Wall-mounted version	13-30 V DC (V+) ± 10%, filtered and regulated 13-30 V DC (V+) ± 10%, filtered and regulated or 115/230 V AC 50/60 Hz (see technical specifications 115/230 V AC)	12-30 V DC (V+) ± 10%, filtered and regulated 12-30 V DC (V+) ± 10%, filtered and regulated or 115/230 V AC 50/60 Hz (see technical specifications 115/230 V AC)
Reversal polarity of DC	protected	
Current consumption without sensor (without consumption of pulse output)	≤ 70 mA - transmitter with relays ≤ 30 mA - transmitter without relay	≤ 70 mA - transmitter with relays ≤ 20 mA - transmitter without relay
Sensor input Frequency range	0.5 Hz or 2.5 Hz up to 1400 Hz - max. voltage: 30 V DC Open collector NPN (with 470 Ω or 2.2 kΩ resistance) or PNP, Coil, TTL, CMOS (with 39 kΩ resistance)	2.5 Hz up to 250 Hz Pulse "Low Power" (open collector NPN)
Sensor output Voltage supply Current consumption	11...28 V DC (V+ - 2 V DC) or +12 V DC or 5 V DC (with a 13-30 V DC powered transmitter); +27 V DC or +12 V DC or 5 V DC (with a 115/230 V AC powered transmitter) max. current available from transmitter: 100 mA	10-28 V DC (V+ - 2 V DC), max. current available from transmitter: 1 mA (internal limitation)
Output Transmitter Signal current Pulse Relay	4-20 mA, configurable in sourcing or sinking mode max. loop impedance: 1200 Ω at 30 V DC; 900 Ω at 24 V DC; 450 Ω at 15 V DC; 300 Ω at 13 V DC; 1000 Ω with a 115/230 V AC voltage supply polarized, potential free, 5...30 V DC; 100 mA, protected, line drop at 100 mA: 1.5 V DC 2 relays, programmable, 3A, 230 V AC	4-20 mA (3-wire with relays; 2-wire without relay) max. loop impedance: 900 Ω at 30 V DC; 600 Ω at 24 V DC; 50 Ω at 12 V DC; 800 Ω with a 115/230 V AC voltage supply polarized, potential free, 5...30 V DC; 100 mA, protected, line drop at 100 mA: 1.5 V DC 2 relays, programmable, 3A, 230 V AC
Technical specifications 115/230 V AC available inside the device Wall-mounted version	Voltage supply: 27 V DC regulated, Max. current: 250 mA Integrated protection: fuse 250 mA temporised Power: 6 VA	

Standards and approvals	Universal transmitter	8025 transmitter
Protection class	IP65 (panel-mounted and wall-mounted version) IP20 (panel-mounted version, inside the cabinet)	
Agreements	CE	CE; CSA, UR recognized

Specific technical data of UR and CSA recognized products	Universal transmitter	8025 transmitter
Relay output	-	30 V AC and 42 V _{peak} max. or 60 V DC max.
Ambient temperature	-	max. 40°C
Relative humidity	-	max. 80 %
Intended for an inner pollution	-	degree 2 environment
Installation category	-	I
Altitude	-	max. 2000 m

DTS 1000011079 EN Version: Q Status: RL (released | freigegeben | validé) printed: 18.06.2009

Ordering chart for compact transmitter Type 8025

Compact flow transmitter or indicator / totalizer with integrated paddle-wheel sensor

A compact flow transmitter or indicator / totalizer Type 8025 consists of:
 - an INSERTION flow transmitter or indicator / totalizer 8025
 - an INSERTION fitting Type S020 (DN15 - DN 400) (Refer to corresponding data sheet - has to be ordered separately)

Specifications	Voltage supply	Output	Relays	Sensor version	Electrical connection	Item no.
Standard output signal transmitter, 2 totalizers	12-30 V DC	4-20 mA (2 wires) + pulse	None	Hall, short	EN 175301-803	418 762
					2 cable glands	418 802
		Hall, long		EN 175301-803	418 763	
				2 cable glands	418 803	
		4-20 mA (3 wires) + pulse	2	Hall, short	2 cable glands	418 778
				Hall, long	2 cable glands	418 779
	115-230 V AC	4-20 mA (2 wires) + pulse	None	Hall, short	2 cable glands	418 423
					Hall, long	2 cable glands
		4-20 mA (3 wires) + pulse	2	Hall, short	2 cable glands	418 431
					Hall, long	2 cable glands
Indicator, 2 totalizers	2 x 9 V DC Batteries	---	None	Coil, short	None	418 403
					Coil, long	None

Note: FKM gasket in standard; 1 Kit including a black EPDM gasket for the sensor, an obturator for an M20 x 1.5 cable gland, a 2 x 6 mm multiway seal and a mounting instruction sheet is supplied with each transmitter.

Ordering chart for remote transmitter Type 8025

Remote 8025 Universal transmitter (panel- or wall-mounted) for connection to Bürkert or other sensors.

A complete remote universal flow transmitter Type 8025 consists of:
 - a remote universal transmitter Type 8025 (wall-mounted or panel-mounted)
 - a Bürkert flow sensor* or any (has to be ordered separately)

Specifications	Voltage supply	Output	Relays	Sensor version*	Electrical connection	Item no.
Universal transmitter, panel mounted 2 totalizers	13-30 V DC	4-20 mA (3 wires)	None	see note	Terminal strip	419 538
		+ pulse	2	see note	Terminal strip	419 537
Universal transmitter, wall-mounted 2 totalizers	13-30 V DC	4-20 mA (3 wires)	None	see note	3 cable glands	419 541
		+ pulse	2	see note	3 cable glands	419 540
	115-230 V AC	4-20 mA (3 wires) + pulse	None	see note	3 cable glands	419 544
		4-20 mA (3 wires) + pulse	2	see note	3 cable glands	419 543

* NOTE: See the chart about compatible and recommended interconnection possibilities with Bürkert sensors.

DTS 1000011079 EN Version: Q Status: RL (released | freigegeben | validé) printed: 18.06.2009

Ordering chart for remote transmitter Type 8025

Remote 8025 transmitter (for panel or wall mounting) for connection to Bürkert “Low Power” sensors only

A complete remote transmitter Type 8025 consists of:

- a remote transmitter Type 8025 (wall-mounted or panel-mounted)
- an INSERTION flow sensor Type 8020 or INLINE flow sensor SE30, (pulse “Low Power” version) (Refer to corresponding datasheet - has to be ordered separately)
- an INSERTION fitting S020 (DN15 -DN 400) or INLINE fitting S030 (DN6 - DN65) (Refer to corresponding datasheet - has to be ordered separately)

Specifications	Voltage supply	Output	Relays	Sensor version*	Electrical connection	Item no.
Transmitter, panel-mounted 2 totalizers	12-30 V DC	4-20 mA (2 wires) + pulse	None	8020 / 8030 ¹⁾	Terminal strip	418 992
Transmitter, panel-mounted 2 totalizers agreements CSA, UR recognized	12-30 V DC	4-20 mA (2 wires) + pulse	None	8020 / 8030 ¹⁾	Terminal strip	552 725
		4-20 mA (3 wires) + pulse	2	8020 / 8030 ¹⁾	Terminal strip	552 726
Transmitter, wall-mounted 2 totalizers	12-30 V DC	4-20 mA (2 wires) + pulse	None	8020 / 8030 ¹⁾	3 cable glands	418 397
	115-230 V AC	4-20 mA (2 wires) + pulse	None	8020 / 8030 ¹⁾	3 cable glands	418 400

* See the chart about compatible and recommended interconnection possibilities with Bürkert sensors.

¹⁾ 8030 = SE30 + S030

Ordering chart - accessories for transmitter Type 8025 (has to be ordered separately)

Specifications	Item no.
Set with 2 cable glands M20 x 1.5 + 2 neoprene flat seals for cable gland or plug + 2 screw-plugs M20 x 1.5 + 2 multiway seals 2 x 6 mm	449 755
Set with 2 reductions M20 x 1.5 /NPT1/2" + 2 neoprene flat seals for cable gland or plug + 2 screw-plugs M20 x 1.5	551 782
Set with 1 stopper for unused cable gland M20 x 1.5 + 1 multiway seal 2 x 6 mm for cable gland + 1 black EPDM gasket for the sensor + 1 mounting instruction sheet	551 775
Ring	619 205
Union nut	619 204
Set with 1 green FKM and 1 black EPDM gasket	552 111
Cable plug EN 175301-803 with cable gland (Type 2508)	438 811
Cable plug EN 175301-803 with NPT1/2" reduction without cable gland (Type 2509)	162 673

Interconnection possibilities with other Bürkert flow sensors

Sensor Type	Remote transmitter version			
	Universal transmitter		8025 transmitter	
	Panel	Wall	Panel	Wall
8020 Hall version (short or long) - Frequency output with pulse signal (NPN, PNP, Open Collector)	X	X	-	-
8020 Hall "Low Power" version (short or long) - Frequency output with pulse signal (NPN, Open Collector)	X	X	X	X
8030/8070 Hall version - Frequency output with pulse signal (NPN, PNP, Open Collector)	X	X	-	-
8030/8070 Hall "Low Power" version - Frequency output with pulse signal (NPN, Open Collector)	X	X	X	X
8030 High temperature - Frequency output with pulse signal (NPN, PNP, Open Collector)	X	X	-	-
SE30 Ex	X	X	-	-
8031 - Frequency output with pulse signal (NPN)	X	X	-	-
8041 - Frequency output with pulse signal (NPN)	X	X ¹⁾	-	-
8071 - Frequency output with pulse signal (NPN)	X	X	-	-

X = Compatible or recommended interconnection possibilities

¹⁾ except sensor with Item no. 419543

Available S020 Fitting DN	DN 15	DN65
	T-fitting S020	Short sensor
Welding tab S020	DN50	DN200 DN350 Short sensor Long sensor
Fusion spigot S020	DN65	DN100 DN400 Short sensor Long sensor
Screw-on S020	DN100	Long sensor DN400
Saddle S020	DN50	Long sensor DN200

Interconnection possibilities with other Bürkert flow sensors

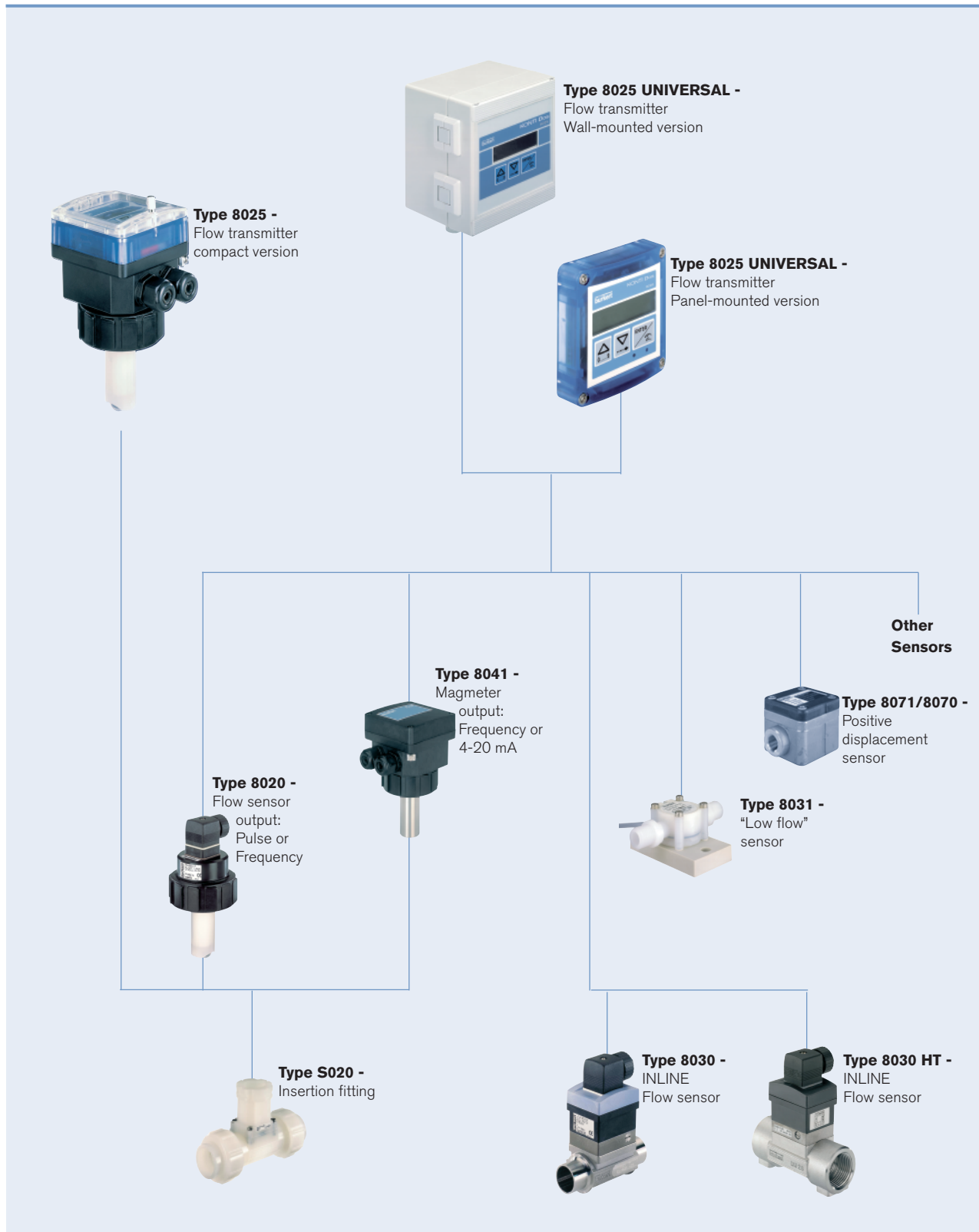

DTS 1000011079 EN Version: Q Status: RL (released | freigegeben | validé) printed: 18.06.2009

To find your nearest Bürkert facility, click on the orange box →

www.burkert.com

In case of special application conditions,
please consult for advice.

Subject to alteration.
© Christian Bürkert GmbH & Co. KG

0906/5_EU-en_00891776