

# FINE CONTROLS (UK) LTD



Fine Controls have been supplying process controls & instrumentation equipment since 1994, & now serves an ever expanding customer base, both in the UK & globally.

We offer a full range of valve & instrumentation products & services, with our product range representing leading technologies & brands:

**Flow:** Flow Meters & Transmitters, Flow Switches, Flow Control Valves & Batch Control Systems

**Temperature:** Temperature Probes & Thermowells, Temperature transmitters, Temperature Regulators & Temperature Displays

**Level:** Level Transmitters & Switches

**Pressure:** Pressure Gauges & Transmitters, Precision & High Pressure Regulators & I-P Converters, Volume boosters.

**Precision Pneumatics:** Pressure Regulators, I-P Converters, Volume Boosters, Vacuum Regulators

**Valves:** Solenoid & Pneumatic Valves, Control Valves & Positioners, Actuated Ball, Globe or Diaphragm Valves & Isolation Valves

**Services:** Repair, Calibration, Panel Build, System Design & Commissioning

A rotork® Brand  
**FAIRCHILD**



**bürkert**



**SIEMENS**



**alcon**  
SOLENOID VALVES

A rotork® Brand



**MIDLAND-ACS**  
A rotork® Brand



**Honeywell**



**Bourdon**  
Baumer Group



**SOLDO**  
CONTROLS

A rotork® Brand



Fine Controls (UK) LTD, Bassendale Road, Croft Business Park,  
Bromborough, Wirral, CH62 3QL UK  
Tel: 0151 343 9966  
Email: sales@finecontrols.com

# Type 6014

3/2-Wege-Klein-Magnetventil  
3/2-way small solenoid valve  
Petite électrovanne à 3/2 voies  
Válvula magnética pequeña de  
3/2 pasos

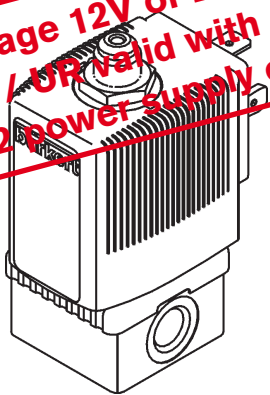

**Voltage 12V or 24V  
UL / UR valid with  
class 2 power supply only**

**bürkert**  
Fluid Control Systems

Sicherheit

(D)

## Bestimmungsgemäße Verwendung

 Bitte beachten Sie die Hinweise dieser Betriebsanleitung sowie die Einsatzbedingungen und zulässigen Daten gemäß Datenblatt Typ 6014, damit das Gerät einwandfrei funktioniert und lange einsatzfähig bleibt. Bei Nichtbeachtung dieser Hinweise sowie bei unzulässigen Eingriffen in das Gerät entfällt jegliche Haftung unsererseits, ebenso erlischt die Garantie auf Geräte u. Zubehörteile. Das Gerät dient ausschließlich als 3/2-Wege-Magnetventil für die in Datenblatt zulässigen Medien. Eine andere oder darüber hinausgehende Benutzung gilt als **nicht bestimmungsgemäß**. Für hieraus resultierende Schäden haftet Bürkert nicht. Das Risiko trägt allein der Anwender.



### ACHTUNG!

Halten Sie sich bei Einsatzplanung und Betrieb des Gerätes an die einschlägigen allgemein anerkannten sicherheitstechnischen Regeln. Treffen Sie geeignete Maßnahmen, um unbeabsichtigtes Betätigen oder unzulässige Beeinträchtigungen auszuschließen. Beachten Sie, daß in Systemen, die unter Druck stehen, Leitungen und Ventile nicht gelöst werden dürfen. Schalten Sie vor Eingriffen in das System in jedem Fall die Spannung ab!

### ACHTUNG!

Achten Sie auf den einwandfreien Sitz der Dichtung beim Verschrauben der Spule mit der Gerätesteckdose.

### ACHTUNG!

Festsitzender Kern bewirkt bei Wechselspannung (AC) Spulenüberhitzung!

### WARNUNG!

Verletzungsgefahr! Bei Dauerbetrieb kann die Spule sehr heiß werden.

Safety

(GB)

## Proper Usage

 To ensure the proper function of the device and promote long service life, you must comply with the information in these Operating Instructions and the application conditions and specifications provided in the Type 6014 Data Sheet. Usage of the device in a manner that is contrary to these Operating Instructions or the application conditions and specifications provided in the Type 6014 Data Sheet is improper and will void your warranty. This device serves exclusively as a 3/2-way solenoid valve for the media stated to be permissible on the data sheet. Any other use is considered improper use. **Bürkert will not be responsible for any improper use of the device.**



### ATTENTION!

Be sure to observe generally accepted safety rules when planning, installing and using this device. For example, take suitable measures to prevent unintentional operations of the device. Do not impair the operation of the device. Do not attempt to detach or unscrew any lines or valves in the system that are under pressure, and always be sure to switch off the voltage supply before working on the system.

### ATTENTION!

When attaching the coil to the plug socket, be sure the seal is properly seated.

### ATTENTION!

With an AC supply the coil can overheat if the core is stuck!

### WARNING!

Do not touch the coil during use as it becomes very hot.

## Utilisation conforme aux prescriptions

 Afin que l'appareil puisse fonctionner parfaitement et pendant longtemps, veuillez observer les instructions contenues dans cette notice d'utilisation ainsi que les conditions d'utilisation et les données admissibles mentionnées dans la fiche technique du type 6014. En cas d'inobservation de ces instructions et d'interventions non autorisées dans l'appareil, nous déclinons toute responsabilité et la garantie couvrant l'appareil et les accessoires s'éteint! L'appareil sert uniquement d'électrovanne 3/2 voies pour les fluides admis selon la fiche technique. Une autre utilisation ou une utilisation excédant ce contexte sera considérée comme **non conforme aux prescriptions**. Pour les dommages qui en résulteraient, le fabricant/fournisseur décline toute responsabilité. L'utilisateur seul en assume le risque.



## ATTENTION!

Pour la planification de l'utilisation et l'exploitation de l'appareil, veuillez vous en tenir aux règles applicables et généralement reconnues en matière de technique de sécurité. Prenez les mesures nécessaires pour exclure tout actionnement involontaire ou des altérations inadmissibles. Notez qu'il n'est pas permis de desserrer des conduites ou des vannes se trouvant sous pression dans des systèmes! Avant d'intervenir dans le système, coupez l'alimentation électrique dans tous les cas!

## ATTENTION!

Veuillez à ce que le joint repose parfaitement lorsque vous visserez la bobine avec le connecteur.

## ATTENTION!

Un noyau coincé provoque avec une tension alternative (AC) une surchauffe de la bobine.

## AVERTISSEMENT!

Risque de blessure! En cas de fonctionnement permanent, la bobine peut devenir très chaude.

## Utilización con arreglo a las disposiciones

 Se ruega observar las indicaciones contenidas en este Manual de instrucciones así como las condiciones de uso y datos admisibles con arreglo a la hoja de servicio Tipo 6014, de modo que el aparato funcione impecablemente y permanezca durante largo tiempo apto para el empleo. La inobservancia de estas indicaciones así como las intervenciones inadmisibles en el aparato suponen la declinación por nuestra parte de toda clase de responsabilidad, además de la extinción de la garantía de los aparatos y de las piezas de los accesorios. El aparato sirve exclusivamente como válvula magnética de 3/2 pasos para los medios autorizados según la hoja de datos. Cualquier otra utilización que vaya más *ella* **no será conforme a las disposiciones**. El fabricante / suministrador no es responsable de los daños que de ello pudieran resultar. El riesgo corresponde únicamente al usuario.



## ¡ATENCIÓN!

Para la planificación y operación del aparato atenderse a las correspondientes reglas generales y reconocidas de la técnica de seguridad. Tomar las medidas apropiadas para excluir accionamientos no intencionados o perjuicios inadmisibles; Prestar atención a que en el caso de sistemas que se encuentren bajo presión no deben desconectarse conducciones y válvulas. Antes de proceder a intervenciones en el sistema desconectar siempre la tensión.

## ¡ATENCIÓN!

Prestar atención al asiento impecable de la empaquetadura al atornillar la válvula con la caja de enchufe para aparatos eléctricos.

## ¡ATENCIÓN!

El núcleo que está fijo provoca el calentamiento de bobinas con corriente alterna (C.A.).

## ¡AVISO!

¡Peligro de lesiones! En estado de operación continua la bobina puede ponerse muy caliente.

## Safety / Sécurité / Seguridad

- ① Spannungsfreie Montage / Voltage-free assembly  
Montage sans tension / Montaje libre de tensión

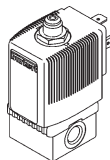

- ② Elektrischer Anschluß / Electrical connection /  
Raccordement électrique / Conexión eléctrica

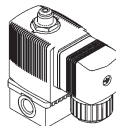
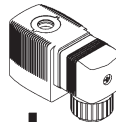

# Sicherheit

(D) (GB) (F) (E)

## Safety / Sécurité / Seguridad

③ Fluidischer Anschluß / Fluid connection /  
Raccordement fluïdique / Conexi3n fluïdica



0 bar, psi, kPa



Durchflußrichtung  
Direction flow  
Sens d'écoulement  
Sentido de paso

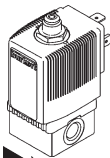

# Technische Daten

(D) (GB)

## Technical Data

Temperatur / Temperature  
Umgebung/ Surroundings



Gehäuse/Housing  
Messing/brass  
Edelstahl/Stainless steel  
Polyamid/Polyamide

Dichtwerkstoff/Sealing material  
FKM -10 .. +100 °C

Nennweite/Nominal size

Wirkungsweise  
Circuit function

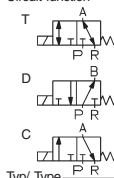

Typ/ Type

Beispiel  
Example

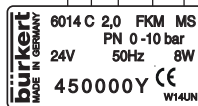

Bestell-Nr. / Id. No.

Spannung (±10 %) - Frequenz - Leistung

Voltage (±10 %) - Frequency - Power

Nennndruck/Nominal pressure

Technische Änderungen vorbehalten

We reserve the right to make technical changes without notice

MAN 1000010024 ML Version: H Status: RL (released / freigegeben)

# Technische Daten

(F) (E)

## Caractéristiques techniques / Datos técnicos

Température d'ambiante  
Temperatura de ambiente



Boîtier/Caja  
Laiton/Lat3n  
Polyamide/Poliamida  
Acier fin/Acero inoxidable

Matériau d'étanchéité/Material de  
estanqueidad  
FKM -10 .. +100 °C

Dimension nominale  
Anchura nominal

Fonctionnement  
Funcionamiento

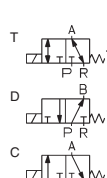

Type/ Tipo

Exemple/  
Ejemplo

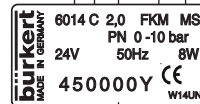

N° id. / N° de pedido

Tension (±10%) - fréquence - puissance

Tensi3n (±10 %) - frecuencia - potencia

Presi3n nominale/Presi3n nominal

Sous réserve de modification techniques.

Nos reservamos el derecho de llevar a cabo modificaciones técnicas

MAN 1000010024 ML Version: H Status: RL (released / freigegeben)

## Niederlassungen / Branch Offices

Chr.-Bürkert-Straße 13-17 74653 Ingelfingen Ph: (0 79 40) 10-111 Fax (0 79 40) 10-448 www.buerkert.com info@de.buerkert.com	Berlin Dortmund Frankfurt Hannover München Stuttgart	Ph: (0 30) 67 97 17 - 0 Ph: (0 23 73) 96 81 - 0 Ph: (0 61 03) 94 14 - 0 Ph: (05 11) 9 02 76 - 0 Ph: (0 89) 82 92 28 - 0 Ph: (07 11) 4 51 10 - 0
--	---	--

## BÜRKERT INTERNATIONAL

<b>A</b>	Ph.	(01) 894 13 33	Fax	(01) 894 13 00
<b>AUS</b>	Ph.	(02) 1300 888 868	Fax	(02) 1300 888 076
<b>B</b>	Ph.	(03) 325 89 00	Fax	(03) 325 61 61
<b>BRA</b>	Ph.	(011) 51 82 00 11	Fax	(011) 51 82 88 99
<b>CDN</b>	Ph.	(905) 847 55 66	Fax	(905) 847 90 06
<b>CH</b>	Ph.	(041) 785 66 66	Fax	(041) 785 66 33
<b>CN</b>	Ph.	(21) 58 68 21 19	Fax	(21) 58 68 21 20
<b>CZ</b>	Ph.	(543) 25 25 05	Fax	(543) 25 25 06
<b>DK</b>	Ph.	(44) 50 75 00	Fax	(44) 50 75 75
<b>E</b>	Ph.	(93) 477 79 80	Fax	(93) 477 79 81
<b>EST</b>	Ph.	(372)644 06 98	Fax	(372)631 3 75 9
<b>F</b>	Ph.	(0388) 58 91 11	Fax	(0388) 57 20 08
<b>HKG</b>	Ph.	24 80 12 02	Fax	24 18 19 45
<b>I</b>	Ph.	(02) 95 90 71	Fax	(02) 95 90 72 51
<b>IND</b>	Ph.	(044)52 30 34 56	Fax	(044)52 30 32 32
<b>J</b>	Ph.	(03) 53 05 36 10	Fax	(03) 53 05 36 11
<b>KOR</b>	Ph.	(02) 34 62 55 92	Fax	(02) 34 62 55 94
<b>N</b>	Ph.	(63) 84 44 10	Fax	(63) 84 44 55
<b>NL</b>	Ph.	(0346) 58 10 10	Fax	(0346) 56 37 17
<b>NZ</b>	Ph.	(09) 622 28 40	Fax	(09) 622 28 47
<b>P</b>	Ph.	(21)212 84 90	Fax	(21)212 84 91
<b>PL</b>	Ph.	(022) 840 60 10	Fax	(022) 840 60 11
<b>RC</b>	Ph.	(02) 26 53 78 68	Fax	(02) 26 53 79 68
<b>RP</b>	Ph.	(02) 776 43 8 4	Fax	(02) 776 43 82
<b>S</b>	Ph.	(040) 664 51 00	Fax	(040) 664 51 01
<b>SA</b>	Ph.	(011)574 60 00	Fax	(011) 454 14 77
<b>SF</b>	Ph.	(09) 54 97 06 00	Fax	(09) 503 12 75
<b>SIN</b>	Ph.	68 44 22 33	Fax	68 44 35 32
<b>TR</b>	Ph.	(0232) 459 53 95	Fax	(0232) 459 76 94
<b>TT</b>	Ph.	(04)643 50 08	Fax	(04)643 70 10
<b>UK</b>	Ph.	(01453) 73 13 53	Fax	(01453) 73 13 43
<b>USA</b>	Ph.	(949) 223 31 00	Fax	(949) 223 31 98

## Montage

(D) (GB) (F) (E)

### Montage / Assembly / Montage / Montaje

- ① Spulmontage / Coil assembly /  
Montage de la bobine / Montaje de bobina

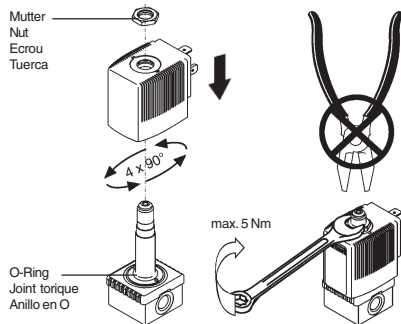

- ② Gerätesteckdose / Instrument socket / Connecteur /  
Caja de enchufe para aparatos eléctricos



Schutzleiter **immer**  
anschließen!  
**Always** connect the  
protective conductor!  
Raccordez **dans tous les**  
**cas** le conducteur de protection!  
Conectar en **todo caso** el  
conductor de puesta a  
tierra!

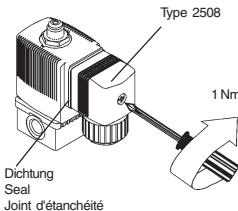

## Montage

(D) (GB) (F) (E)

### Montage / Assembly / Montage / Montaje

- ③ Rohrleitungen reinigen / Cleaning the pipework  
Nettoyer les conduites / Limpieza tuberías

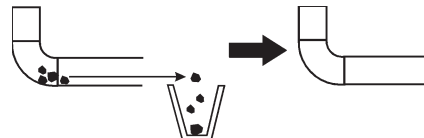

- ④ Einbaulage beliebig / Any assembly position /  
Position de montage quelconque / Sentido de  
montaje discrecional

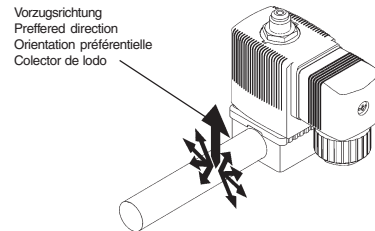

Montage / Assembly / Montage / Montaje

- ⑤ Schmutzfänger / Dirt trap / Collecteur d'impuretés / Sentido de paso

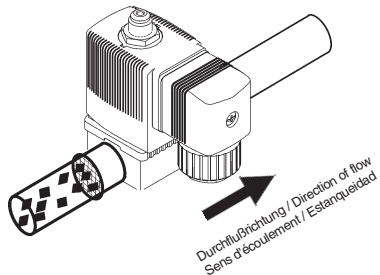

- ⑥ Abdichtung / Seal / Etanchéification / Atomillado

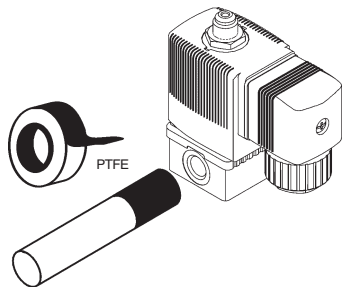

Montage / Assembly / Montage / Montaje

- ⑦ Einschrauben der Rohrleitungen / Screwing in the pipe connections / Vissage les conduites / Averías las tuberías

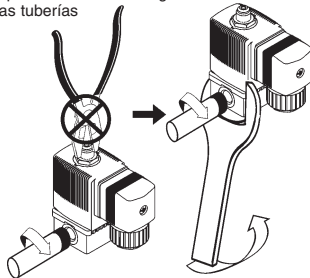

- ⑧ Flanschanschluß  
Flange connections  
Raccords à brides  
Conexión de brida

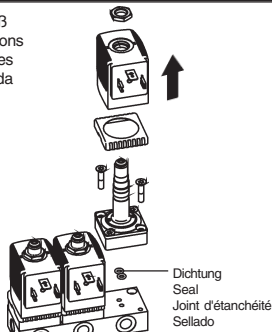

Troubleshooting / Dérangements / Averías

- Spannung prüfen! / Check the voltage!  
Vérifier la tension! / Comprobar tensión!



- Druck prüfen! / Check the pressure!  
Vérifier la pression! / Comprobar presión!



- Rohrleitungen prüfen! / Check the piperun!  
Vérifier les conduites! / Comprobar tuberías!

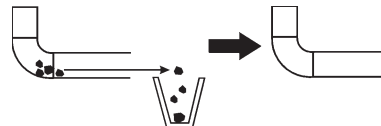

## Spare parts / Pièces de rechange / Pieza de repuesto

- 1** D Spule  
GB Coil  
F Bobine  
E Bobina
- 2** D Armatur  
GB Armature  
F Armature  
E Armadura

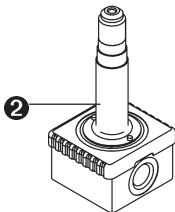
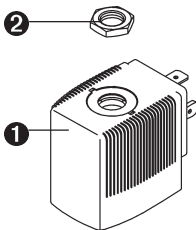

Type 6014

## Spare parts / Pièces de rechange / Pieza de repuesto

- D Bitte bestellen Sie Spule oder Armatur komplett unter Angabe der Identnummer des Gerätes lt. Typenschild, z. B. Spulensatz für Typ 6014 Identnummer XXX XXX X.
- GB Please order coils or armatures complete, quoting the ident. number of the device according to the rating plate; e. g., coil set for Type 6014 Id. No. XXX XXX X.
- F Pièces de rechange: veuillez commander la bobine ou l'armature complète en indiquant le numéro d'identification de l'appareil selon la plaquette signalétique: par ex. jeu de bobine pour type 6014 N° Id. XXX XXX X.
- E Piazas de rerecambio: Pida bobina o accesorios completos indicando el número de identidad del aparato; placa indicadora del tipo; por ejemplo: juego de bobinas para tipo 6014 núm. de id. XXX XXXX.

## Approvals / Homologation / Aprobaciones

- e 1  
023186 D Geräte, die das Typgenehmigungszeichnung tragen müssen, wurden beim Kraftfahrtbundesamt unter der Typgenehmigungsnummer **e1\*72/245\*95/54\*3186\*00** genehmigt und werden mit dem gezeigten Typgenehmigungszeichen in den Verkehr gebracht. Einen Auszug der Typgenehmigung erhalten Sie unter der unten stehenden Adresse.
- e 1  
023186 GB Devices that must carry the type approval marking have been approved by the Federal Office for Motorised Transport under the type approval number **e1\*72/245\*95/54\*3186\*00** and will be brought into circulation with the indicated type approval marking. You can obtain an excerpt from the type approval from the address below.
- e 1  
023186 F Les appareils qui doivent porter la marque d'homologation ont été homologués au „Kraftfahrtbundesamt (Service fédéral de la circulation automobile)“ sous le numéro **e1\*72/245\*95/54\*3186\*00** et seront mis en circulation avec la marque d'homologation indiquée. Vous recevrez un extrait de l'homologation à l'adresse ci-dessous
- e 1  
023186 E Los aparatos que deben llevar el símbolo de aprobación de tipo fueron aprobados por la Oficina federal de vehículos motorizados con el número de aprobación de tipo **e1\*72/245\*95/54\*3186\*00** y serán puestos en circulación con el símbolo de aprobación indicado. Para un extracto de la aprobación de tipo, rogamos ponerse en contacto con la dirección siguiente.

Bürkert Werke GmbH & Co. KG,  
 Zulassungsbeauftragter,  
 Christian Bürkert Str. 13-17,  
 D-74653 Ingelfingen