

FINE CONTROLS (UK) LTD



Fine Controls have been supplying process controls & instrumentation equipment since 1994, & now serves an ever expanding customer base, both in the UK & globally.

We offer a full range of valve & instrumentation products & services, with our product range representing leading technologies & brands:

Flow: Flow Meters & Transmitters, Flow Switches, Flow Control Valves & Batch Control Systems

Temperature: Temperature Probes & Thermowells, Temperature transmitters, Temperature Regulators & Temperature Displays

Level: Level Transmitters & Switches

Pressure: Pressure Gauges & Transmitters, Precision & High Pressure Regulators & I-P Converters, Volume boosters.

Precision Pneumatics: Pressure Regulators, I-P Converters, Volume Boosters, Vacuum Regulators

Valves: Solenoid & Pneumatic Valves, Control Valves & Positioners, Actuated Ball, Globe or Diaphragm Valves & Isolation Valves

Services: Repair, Calibration, Panel Build, System Design & Commissioning

A rotork® Brand
FAIRCHILD



bürkert



SIEMENS



alcon
SOLENOID VALVES

A rotork® Brand



MIDLAND-ACS
A rotork® Brand



Honeywell



Bourdon
Baumer Group



SOLDO
CONTROLS

A rotork® Brand



Fine Controls (UK) LTD, Bassendale Road, Croft Business Park,
Bromborough, Wirral, CH62 3QL UK
Tel: 0151 343 9966
Email: sales@finecontrols.com

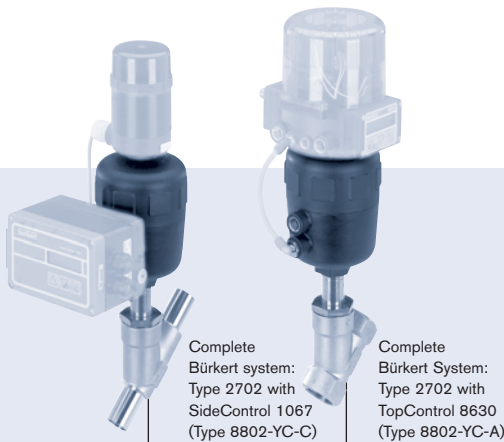

Type 2702 can be combined with...

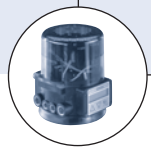

Type 8630

Positioner TopControl continuous

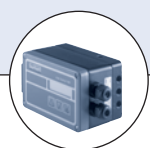

Type 1067

Positioner SideControl

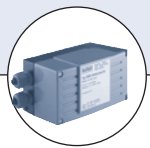

Type 8635

Positioner SideControl

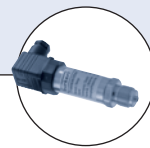

Type 8323

Pressure transmitter

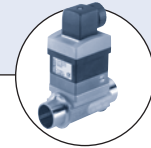

Type 8030

Flow sensor

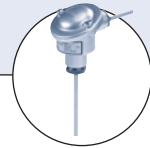

Type ST20

Temperature sensor

The 2702 Control Valve consists of an 316L angle seat body with a rugged pneumatic piston actuator. The parabolic trim results in a flow characteristic approximately 35% larger than conventional control valves. It is available in either stainless steel on stainless steel or with a durable PTFE seal for tight shut-off.

Type 2702 can be actuated by the Continuous TopControl Type 8630 or SideControl Type 1067 and 8635. TopControl/SideControl thus forms a mechanical and functional unit with the pneumatic actuator as a complete control valve system.

This system has been engineered for reliable accurate control in applications where high flow rate is an advantage.

Proven Applications

- Food and beverage CIP/SIP and auxiliary processes with steam, chilled water and glycol
- Textile machinery (steam, water, air) and dyeing
- Heat exchangers and autoclaves
- Sterilizers and washers
- Distillation apparatus
- Packaging and filling machinery

2/2-way Angle Seat Control Valve, threaded and weld end connections, DN 13-50

- Excellent control characteristic and high flow rates
- Durable, robust and cost effective
- Ultra compact design, low weight
- Quality certifications available

Technical data

Materials	
Body	Cast stainless steel (conform to 1.4409)
Actuator	PA polyamide (PPS on request)
Sealing	
	St.st./St.st. (stainless steel/stainless steel), PTFE/St.st. (PTFE/stainless steel)
Seat leakage IEC 534-4/EN 1349	
	Shut-off class IV for St.st./St.st. Shut-off class VI for PTFE/St.st.
Process media gases and liquids (vacuum version on request)	
	For neutral gases, water, alcohols, oils, fuels, hydraulic liquids, salt solutions, lyes, organic solvents, steam (10 bar(abs)/+180°C)
Viscosity	
	Max. 600 mm ² /s
Packing gland	
	PTFE V-rings (silicone grease) with spring compensation
Nominal pressure	
	PN 25 (body)
Temperature	
Fluid	-10°C to +180°C ¹⁾ (max. +130°C for PTFE/St.st. sealing recommended)
Ambient	-10°C to +60°C ¹⁾
Control medium	
	Compressed air
Pilot pressure	
	5.5 to 7 bar
Pilot air ports	
	G 1/4 stainless steel (St.st.)
Flow direction	
	Below seat
Flow characteristic	
	Modified equal percentage
Control ratio (Kvs/KvO)	
	More than 50:1
Port connections	
Threaded	
G	<ul style="list-style-type: none"> ▪ DIN ISO 228 (face-to-face DIN 3202-4 M4 on request , DIN 3202-4 M8) ▪ ANSI/ASME B1.20.1 (face-to-face DIN 3202-4 M4) ▪ ISO 7 (face-to-face DIN 3202-4 M4)
NPT	
Rc	
Weld end	
ISO	<ul style="list-style-type: none"> ▪ EN ISO 1127/ISO 4200 ▪ DIN 11850 series 2 ▪ SMS 3008 (on request) ▪ BS 4825 part 1 (on request) ▪ ASME BPE (on request)
DIN	
SMS	
OD-Tube	
Mounting position	
	Any, preferably upright

1) high temperature on request

Ordering information for Angle Seat Valve System Type 8802-YC

A complete continuous angle seat valve system Type 8802-YC consists of an angle seat control valve Type 2702 and a valve actuation system TopControl Type 8630 or SideControl Type 1067 or Type 8635. The positioners are only delivered in combination with an actuator as a part of a complete control valve. The following information is necessary for the selection of a complete control valve:

• **Item no.** of the seat control valve **Type 2702** (see Ordering chart)

• **Item no.** of the desired positioner **Type 8630, Type 1067 or Type 8635** (see separate datasheets)

Examples for variations of continuous angle seat valve systems

Angle seat valve Type 2702 with required process connection

Positioner



Angle seat valve with required body and port connection

1



**Angle seat valve
TopControl system**
2702+8630
(Type 8802-YC-A)

2



**Angle seat valve
SideControl system**
2702+1067
(Type 8802-YC-C)

3



**Angle seat valve
SideControl system**
2702+8635
(Type 8802-YC-B)

TopControl Type 8630



0/4-20 mA
0-5/10 V



PROFIBUS
DeviceNet™

The Type 8630 is an electro-pneumatic positioner for usage with pneumatically operated process valves. The compact design with integrated position encoder and LCD display was developed for demanding applications of the process industry.

Main customer benefits are:

- Time saving algorithms for temperature, flow and pressure PID parameters through ProcessTUNE function.
- Quick and simple menu driven parameterization through keyboard
- Field bus communication via Profibus DPV1 or DeviceNet
- Fits seamlessly to Bürkert's process valve systems
- Break resistant housing
- Suitable for hazardous locations per zone 2 and 22

SideControl Type 1067



0/4-20 mA
0-10 V



Type 1067 is a digital electro-pneumatic positioner with an integrated process controller for precise control requirements. The compact and sturdy design with integrated position encoder and LCD display was developed for demanding applications of the process industry.

Main customer benefits are:

- Quick and simple menu driven parameterization through keyboard
- Remote setpoint adjustment via a 0/4-20 mA or 0-10 VDC signal
- 3-wire, 24 VDC connection
- Adaptation according to IEC534-6 for lift and swivel drives
- Sturdy aluminium housing
- Remote model with separate positioner
- Suitable for hazardous locations per zone 2 and 22

SideControl Type 8635, 2-wire, intrinsically safe



4-20 mA

PROFIBUS
DeviceNet™



Type 8635 is a digital electro-pneumatic positioner with an optional, integrated process controller for precise control requirements. The compact design with integrated position encoder and LCD display was developed for demanding applications of the process industry.

Main customer benefits are:

- Time saving algorithms for temperature, flow and pressure PID parameters through ProcessTUNE function.
- Quick and simple menu driven parameterization through keyboard or Profibus PA
- Remote setpoint adjustment via a 4-20 mA signal
- Adaptation according to IEC534-6 for lift and swivel drives
- Rugged anodised aluminium housing
- Suitable for hazardous locations per zone 1, zone 21 or zone 2 and 22

Application example

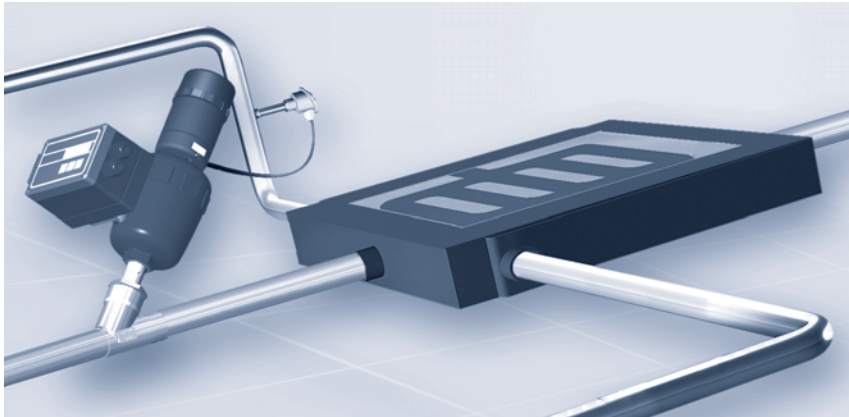

A 2702 control valve with a 1067 local PID controller. The valve is controlling the exit temperature of a media flowing through a heat exchanger. The process input is a simple temperature transmitter.

Flow characteristic

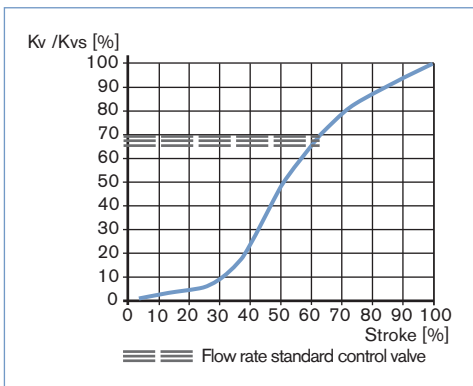

Remarks on the flow characteristic

Modified equi-percentile flow characteristic, engineered for a quick response during peak flow demand (an advantage for many processes like heating/cooling with heat exchangers) and fine control at lower flow.

Kvs values [m³/h]

Port size and orifice [mm]	Actuator size [mm]	Stroke [%]										
		5	10	20	30	40	50	60	70	80	90	100
13/15	80	0.23	0.24	0.26	0.35	0.7	1.85	2.9	3.5	4	4.3	4.5
20	80	0.30	0.33	0.42	0.7	2.85	5.3	6.6	7.5	8.2	8.6	9
25	80	0.39	0.41	0.60	1.25	4.5	8.5	10.5	12.2	13.5	14.2	15
32	80	0.55	0.65	0.95	1.5	4	9.3	13.8	16.5	18.8	21	23
40	100	0.65	0.85	1.5	5	14	20	25	27	30	33	35
50	100	1	1.3	2	5	16	27	34	41	45	49	53

Ordering chart for Angle seat valve (without positioner)

Body with threaded port connection acc. G, DIN ISO 228 and NPT, ANSI/ASME B1.20.1, flow below seat

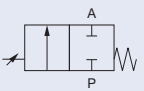
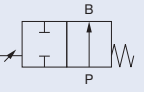
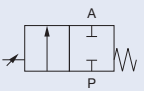
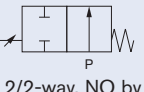
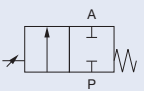
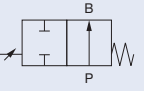
	Control function	Port size and orifice		Actuator size Ø [mm]	Kvs value [m³/h]	Operating pressure ≤ +180°C [bar]	Item no. seal system* St.st./St.st.	Item no. seal system* PTFE/St.st.
		[mm]	[inch]					
Acc. G, DIN ISO 228, face-to-face acc. DIN 3202-4 M4 (long dimension), flow below seat, on request								
 <p>2/2-way, NC by spring return</p>	13	1/2"	80	4.5	16	■	■	
	20	3/4"	80	9	16	■	■	
	25	1"	80	15	16	■	■	
	32	1 1/4"	80	23	15	■	■	
	40	1 1/2"	100	35	12.5	■	■	
	50	2"	100	53	7.2	165 543	165 520	
 <p>2/2-way, NO by spring return</p>	13	1/2"	80	4.5	16	■	■	
	20	3/4"	80	9	16	■	■	
	25	1"	80	15	16	■	■	
	32	1 1/4"	80	23	15	■	■	
	40	1 1/2"	100	35	12.5	■	■	
	50	2"	100	53	7.2	165 598	165 575	
Acc. G, DIN ISO 228, face-to-face acc. DIN 3202-4 M8 (short dimension), flow below seat								
 <p>2/2-way, NC by spring return</p>	13	1/2"	80	4.5	16	165 523	165 486	
	20	3/4"	80	9	16	165 526	165 489	
	25	1"	80	15	16	165 531	165 513	
	32	1 1/4"	80	23	15	165 537	165 515	
	40	1 1/2"	100	35	12.5	165 540	165 518	
 <p>2/2-way, NO by spring return</p>	13	1/2"	80	4.5	16	165 580	165 546	
	20	3/4"	80	9	16	165 584	165 549	
	25	1"	80	15	16	165 566	165 553	
	32	1 1/4"	80	23	15	165 569	165 557	
	40	1 1/2"	100	35	15.2	165 592	165 572	
Acc. NPT, ANSI/ASME B1.20.1, face-to-face acc. DIN 3202-4 M4, flow below seat								
 <p>2/2-way, NC by spring return</p>	13	1/2"	80	4.5	16	462 101	462 095	
	20	3/4"	80	9	16	462 102	462 096	
	25	1"	80	15	16	462 103	462 097	
	32	1 1/4"	80	23	15	462 104	462 098	
	40	1 1/2"	100	35	12.5	462 105	462 099	
	50	2"	100	53	7.2	462 106	462 100	
 <p>2/2-way, NO by spring return</p>	13	1/2"	80	4.5	16	462 115	462 107	
	20	3/4"	80	9	16	462 116	462 108	
	25	1"	80	15	16	462 110	462 111	
	32	1 1/4"	80	23	15	462 121	462 112	
	40	1 1/2"	100	35	12.5	462 122	462 113	
	50	2"	100	53	7.2	462 123	462 114	

*seal system:

- on request
- St.st./St.st.: plug stainless steel/seat stainless steel
- PTFE/St.st.: (soft sealing) plug PTFE/seat stainless steel

 Further versions on request

Material
Actuator: PPS

Ordering chart for Angle seat valve (without positioner)

Body with threaded port connection acc. Rc, ISO 7, flow below seat

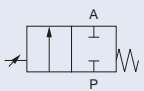
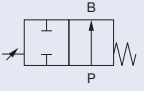
	Control function	Port size and orifice		Actuator size Ø [mm]	Kvs value [m³/h]	Operating pressure ≤ +180°C [bar]	Item no. seal system* St.st./St.st.	Item no. seal system* PTFE/St.st.
		[mm]	[inch]					
Acc. Rc, ISO 7, face-to-face acc. DIN 3202-4 M4, flow below seat								
A  2/2-way, NC by spring return	13	1/2"	80	4.5	16	507 147	507 141	
	20	3/4"	80	9	16	507 148	507 142	
	25	1"	80	15	16	507 149	507 143	
	32	1 1/4"	80	23	15	507 150	507 144	
	40	1 1/2"	100	35	12.5	507 151	507 145	
	50	2"	100	53	7.2	507 152	507 146	
B  2/2-way, NO by spring return	13	1/2"	80	4.5	16	507 165	507 153	
	20	3/4"	80	9	16	507 166	507 154	
	25	1"	80	15	16	507 155	507 161	
	32	1 1/4"	80	23	15	507 156	507 162	
	40	1 1/2"	100	35	12.5	507 157	507 163	
	50	2"	100	53	7.2	507 158	507 164	

*seal system:

- St.st./St.st.: plug stainless steel/seat stainless steel
- PTFE/St.st.: (soft sealing) plug PTFE/seat stainless steel

 Further versions on request

Material

Actuator: PPS

Ordering chart for Angle seat valve (without positioner)

Body with weld end acc. EN ISO 1127/ISO 4200 and DIN 11850 S2, flow below seat

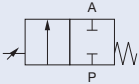
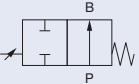
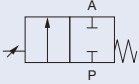
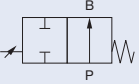
	Control function	Port size and orifice		Connection DS x WS [mm]	Actuator size Ø [mm]	Kvs value [m³/h]	Operating pressure ≤ +180°C [bar]	Item no. seal system* St.st./St.st.	Item no. seal system* PTFE/St.st.
		[mm]	[inch]						
Acc. EN ISO 1127/ISO 4200, flow below seat									
 <p>2/2-way, NC by spring return</p>	15	1/2"	21.3 x 1.6	80	4.5	16	165 524	165 487	
	20	3/4"	26.9 x 1.6	80	9	16	165 529	165 511	
	25	1"	33.7 x 2.0	80	15	16	165 534	165 514	
	32	1 1/4"	42.4 x 2.0	80	23	15	165 538	165 516	
	40	1 1/2"	48.3 x 2.0	100	35	12.5	165 541	165 519	
	50	2"	60.3 x 2.0	100	53	7.2	165 544	165 521	
 <p>2/2-way, NO by spring return</p>	15	1/2"	21.3 x 1.6	80	4.5	16	165 582	165 547	
	20	3/4"	26.9 x 1.6	80	9	16	165 585	165 551	
	25	1"	33.7 x 2.0	80	15	16	165 567	165 554	
	32	1 1/4"	42.4 x 2.0	80	23	15	165 570	165 559	
	40	1 1/2"	48.3 x 2.0	100	35	12.5	165 596	165 573	
	50	2"	60.3 x 2.0	100	53	7.2	165 599	165 578	
Acc. DIN 11850 series 2, flow below seat									
 <p>2/2-way, NC by spring return</p>	15	1/2"	19.0 x 1.5	80	4.5	16	165 525	165 488	
	20	3/4"	23.0 x 1.5	80	9	16	165 530	165 512	
	25	1"	29.0 x 1.5	80	15	16	165 536	165 030	
	32	1 1/4"	35.0 x 1.5	80	23	15	165 539	165 517	
	40	1 1/2"	41.0 x 1.5	100	35	12.5	165 542	164 778	
	50	2"	53.0 x 1.5	100	53	7.2	165 545	165 522	
 <p>2/2-way, NO by spring return</p>	15	1/2"	19.0 x 1.5	80	4.5	16	165 583	165 548	
	20	3/4"	23.0 x 1.5	80	9	16	165 586	165 552	
	25	1"	29.0 x 1.5	80	15	16	165 568	165 556	
	32	1 1/4"	35.0 x 1.5	80	23	15	165 591	165 571	
	40	1 1/2"	41.0 x 1.5	100	35	12.5	165 597	165 574	
	50	2"	53.0 x 1.5	100	53	7.2	165 600	165 579	

*seal system:

- St.st./St.st.: plug stainless steel/seat stainless steel
- PTFE/St.st.: (soft sealing) plug PTFE/seat stainless steel

 Further versions on request
**Material**

Actuator: PPS

**Port connection**

SMS 3008, BS 4825 part 1, ASME BPE

Materials

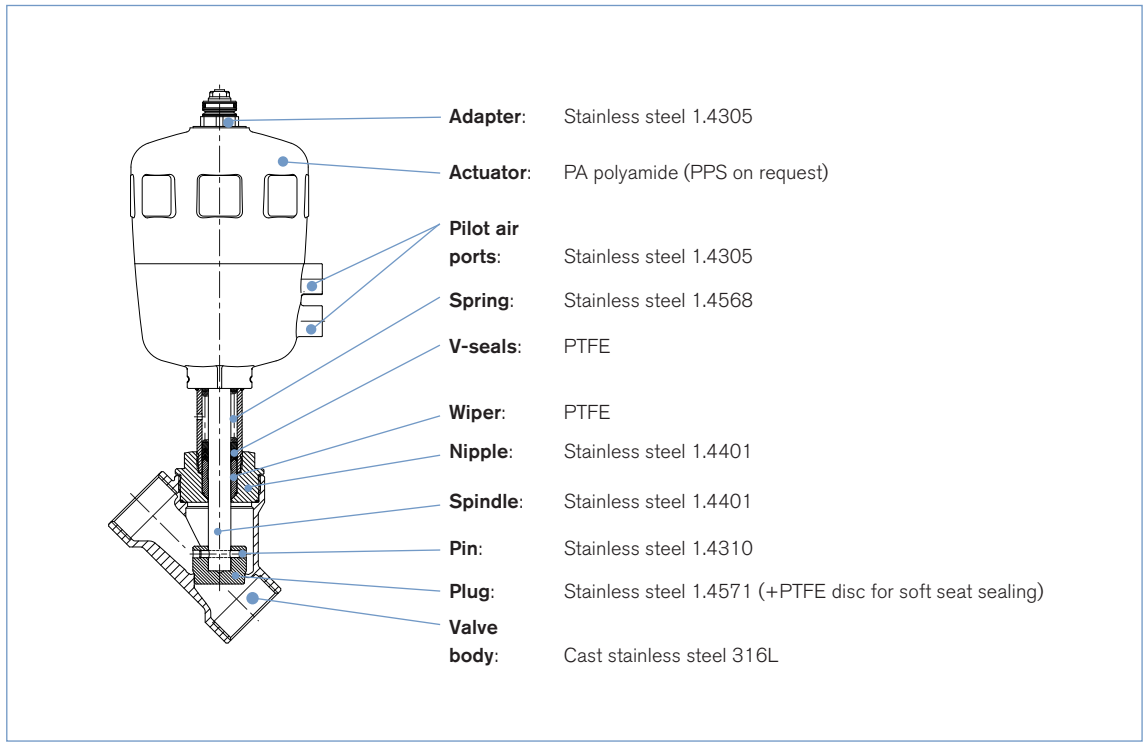

Spare parts for Type 2702 – DN 13-50 (on request)

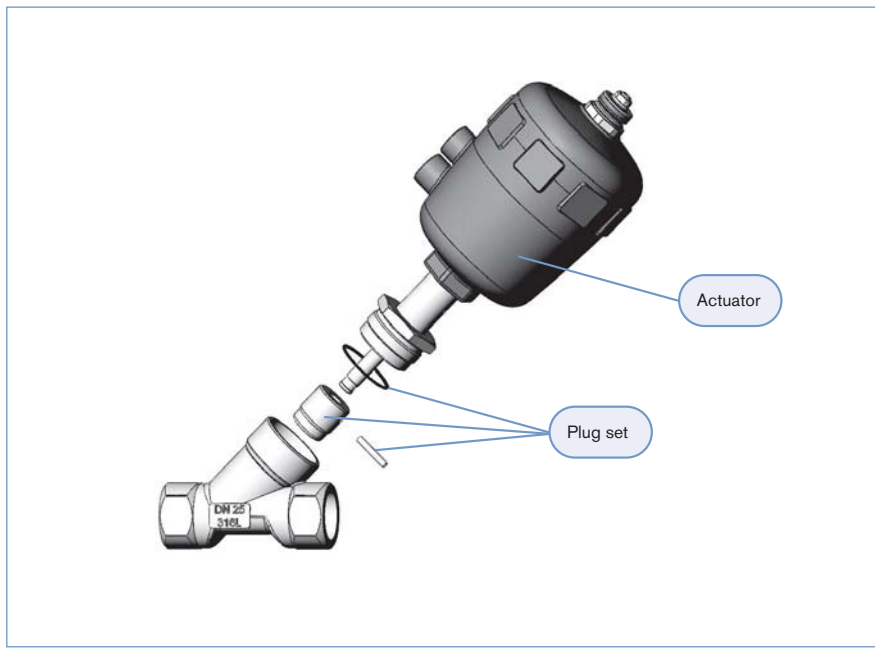

Dimensions Angle seat valve [mm]

Angle seat valve with threaded and weld end connection

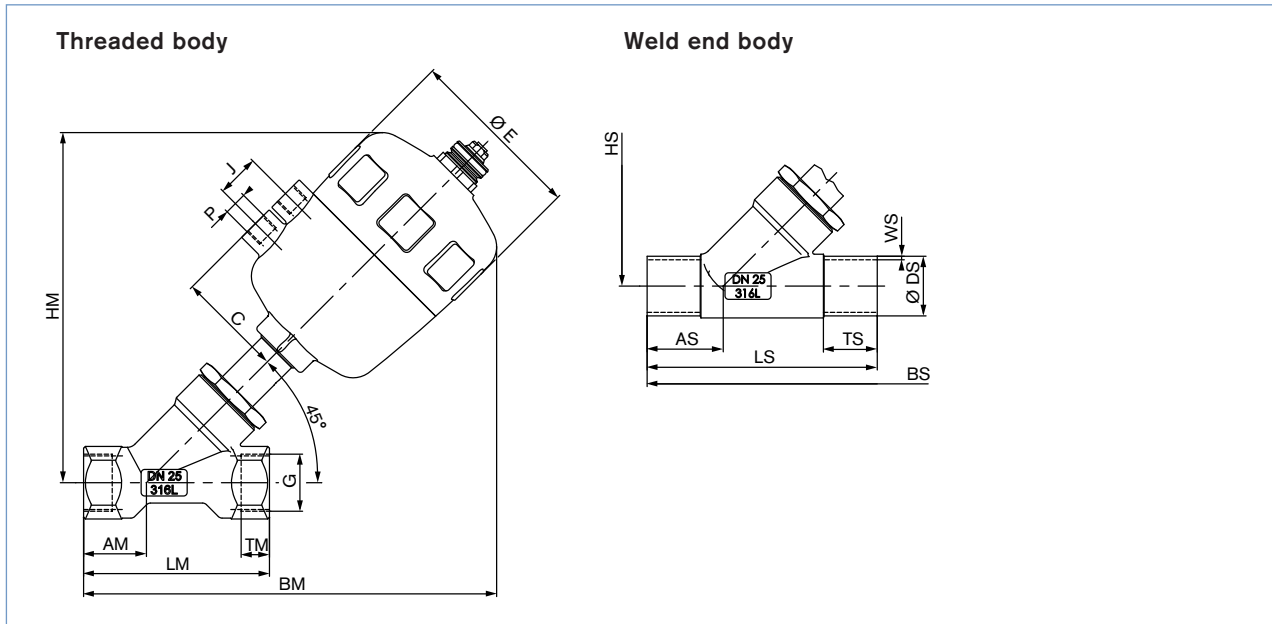

All actuators

Port size and orifice [mm]	Actuator size Ø [mm]	ØE	C	P	J
13/15	80	101	60	G 1/4	24
20	80	101	60	G 1/4	24
25	80	101	60	G 1/4	24
32	80	101	60	G 1/4	24
40	100	127	73	G 1/4	30
50	100	127	73	G 1/4	30

Threaded ends

All threaded bodies		G, NPT and Rc thread with face-to-face acc. DIN 3202-4 M4									G thread with face-to-face acc. DIN 3202-4 M8				
Orifice [mm]	HM	Orifice			G thread		NPT thread		Rc thread		BM	LM	AM	G	TM
		BM	LM	AM	G	TM	G	TM	G	TM					
13	193	224	85	31	G 1/2	14	NPT 1/2	13.7	Rc 1/2	13.2	217	65	24	G 1/2	14
20	193	228	95	35	G 3/4	16	NPT 3/4	14	Rc 3/4	14.5	220	75	27	G 3/4	16
25	198	234	105	35.5	G 1	18	NPT 1	16.8	Rc 1	16.8	228	90	29.5	G 1	18
32	205	246	120	41	G 1 1/4	16	NPT 1 1/4	17.3	Rc 1 1/4	19.1	241	110	36	G 1 1/4	16
40	260	300	130	40	G 1 1/2	18	NPT 1 1/2	17.3	Rc 1 1/2	19.1	295	120	35	G 1 1/2	18
50	272	317	150	45	G 2	24	NPT 2	17.6	Rc 2	23.4	-	-	-	-	-

Weld ends

All weld end bodies		EN ISO 1127/ISO 4200 and DIN 11850 series 2									BS 4825 P1, ASME BPE, SMS 3008										
Orifice [mm]	HS	Orifice			EN ISO 1127/ISO 4200			DIN 11850 S2			Orifice [inch]	BS 4825 P1, ASME BPE			SMS 3008						
		BS	LS	AS	ØDS	TS	WS	ØDS	TS	WS		BS	LS	AS	ØDS	TS	WS ¹⁾	WS ²⁾	ØDS	TS	WS
15	198	232	100	34	21.3	20	1.6	19	20	1.5	1/2"	244	135	46	12.7	38	1.2	1.65	12	38	1
20	198	237	115	39	26.9	25	1.6	23	20	1.5	3/4"	250	145	52	19.05	38	1.2	1.65	18	38	1
25	199	242	130	43	33.7	30	2	29	26	1.5	1"	250	152	51	25.4	38	1.65	1.65	25	38	1.2
32	209	244	145	40	42.4	26	2	35	26	1.5	-	-	-	-	-	-	-	-	-	-	-
40	263	312	160	49	48.3	30	2	41	26	1.5	1 1/2"	323	182	60	38.1	38	1.65	1.65	38	38	1.2
50	277	327	175	50	60.3	30	2.6	53	26	1.5	2"	341	210	64	50.8	45	1.65	1.65	51	45	1.2

¹⁾ BS 4825 P1 ²⁾ ASME BPE

Dimensions Control valve systems [mm]

Control valve system 2702 + 1067

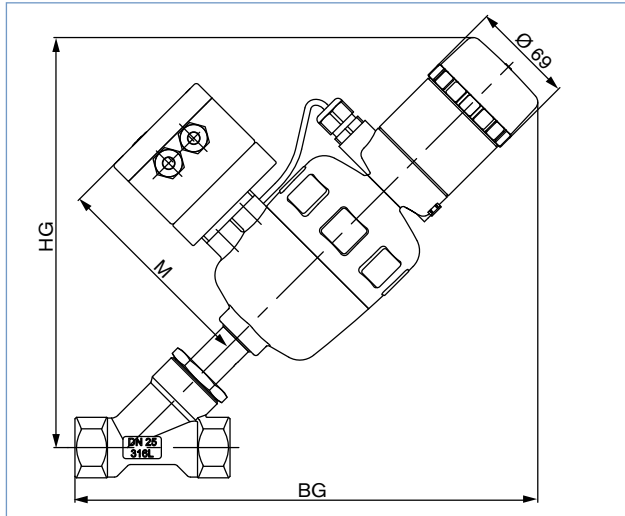

Control valve system 2702 + 8635

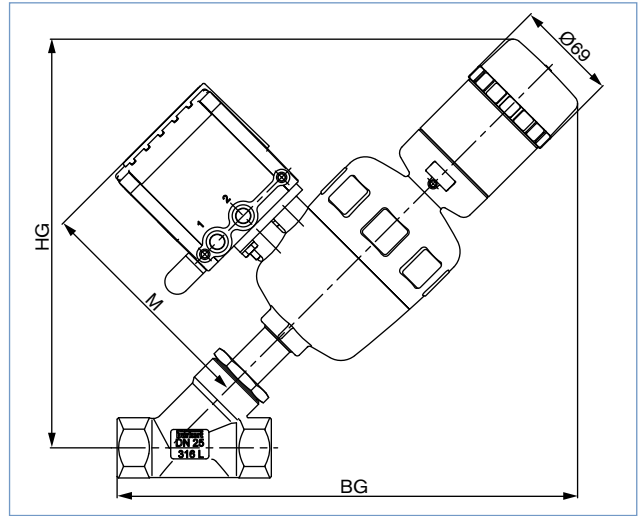

All bodies orifice [mm]	Actuator size [mm]	M		Threaded body			Weld end body		
		2702+ 1067	2702+ 8635	HG	BG	G thread with face-to-face acc. DIN 3202-4 M4	HG	BG	BS 4825 P1, ASME BPE, SMS 3008
13/15	80	142	160	273	304	297	278	312	324
20	80	142	160	273	308	300	278	317	330
25	80	142	160	278	314	308	279	322	330
32	80	142	160	285	326	321	289	324	-
40	100	155	173	336	376	371	340	389	400
50	100	155	173	349	394	-	354	404	418

Control valve system 2702 + 8630

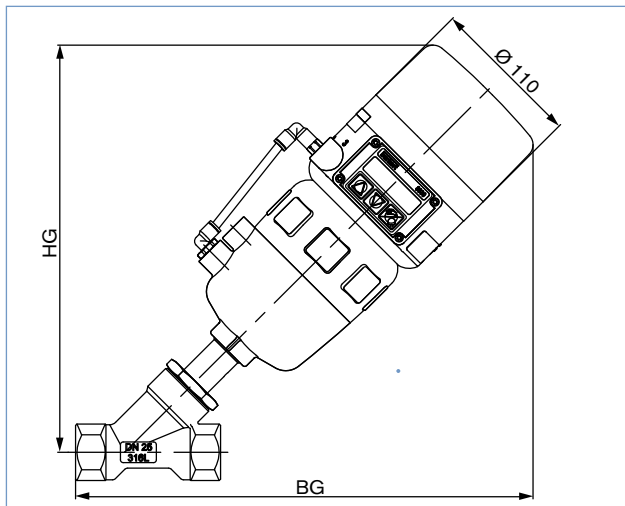

All bodies orifice [mm]	Actuator size [mm]	Threaded body			Weld end body		
		HG	BG	G thread with face-to-face acc. DIN 3202-4 M4	HG	BG	BS 4825 P1, ASME BPE, SMS 3008
13/15	80	291	322	315	296	330	342
20	80	291	326	318	296	335	348
25	80	296	332	326	297	340	348
32	80	303	344	339	307	342	-
40	100	354	394	389	358	407	418
50	100	367	412	-	372	422	436

Note
You can fill out the fields directly in the PDF file before printing out the form.

Control valves – request for quotation

Please fill out and send to your nearest Bürkert facility* with your inquiry or order

Company	Contact person
Customer no.	Department
Address	Tel./Fax
Postcode/town	E-Mail

= mandatory fields to fill out Quantity Required delivery date

Operating data

Site of control	<input type="text"/>			
Measuring and control task	<input type="text"/>			
Pipeline	DN	<input type="text"/>	PN	<input type="text"/>
Pipe material	<input type="text"/>			
<input type="checkbox"/> Process medium	<input type="text"/>			
<input type="checkbox"/> Type of media	<input type="checkbox"/> Liquid	<input type="checkbox"/> Steam	<input type="checkbox"/> Gas	
<input type="checkbox"/> Flow rate (Q, Q_N, W) ¹⁾	min	standard	max	unit
<input type="checkbox"/> Temperature at valve inlet T1	<input type="text"/>	<input type="text"/>	<input type="text"/>	<input type="text"/>
<input type="checkbox"/> Absolute pressure at valve inlet P1	<input type="text"/>	<input type="text"/>	<input type="text"/>	<input type="text"/>
<input type="checkbox"/> Absolute pressure at valve outlet P2	<input type="text"/>	<input type="text"/>	<input type="text"/>	<input type="text"/>
Steam pressure P_v	<input type="text"/>	<input type="text"/>	<input type="text"/>	<input type="text"/>
Kinematic viscosity (ν)	<input type="text"/>	mm ² /s or cSt		
Dynamic viscosity (η)	<input type="text"/>	mPa.s or cP		
Standard density	<input type="text"/>	Kg/m ³		
Max. sound level accepted	<input type="text"/>	dB (A)		

¹⁾ standard unit: Liquid Q = m³/h; Steam W = kg/h; Gas Q_N = Nm³/h

Valve features

Control valve type	<input type="checkbox"/> Globe	<input type="checkbox"/> Angle seat	<input type="checkbox"/> Diaphragm	<input type="checkbox"/> Ball valve	<input type="checkbox"/> Butterfly	<input type="checkbox"/> Other
Body material	<input type="checkbox"/> Stainless steel	<input type="checkbox"/> PVC	<input type="checkbox"/> PP	<input type="checkbox"/> PVDF	<input type="checkbox"/> Other	
Surface finish²⁾	<input type="text"/> internal			<input type="text"/> external		
Seat sealing material	<input type="checkbox"/> Metal	<input type="checkbox"/> PTFE	<input type="checkbox"/> EPDM ²⁾	<input type="checkbox"/> FKM ²⁾		
Nominal pressure	PN	<input type="text"/>				
Nominal size	DN	<input type="text"/>				
Type of connection	<input type="checkbox"/> Flange	<input type="checkbox"/> Socket union	<input type="checkbox"/> Welded	<input type="checkbox"/> Internal thread	<input type="checkbox"/> External thread	<input type="checkbox"/> Tri-Clamp [®]
Standard connection	<input type="checkbox"/> ISO	<input type="checkbox"/> DIN	<input type="checkbox"/> ANSI	<input type="checkbox"/> JIS	<input type="checkbox"/> Other	
Function	<input type="checkbox"/> NC ³⁾	<input type="checkbox"/> NO ³⁾	<input type="checkbox"/> Double-acting			
Pilot pressure	<input type="text"/> min.		<input type="text"/> max.			

²⁾ only diaphragm valve ³⁾ NC: normally closed by spring action; NO: normally open by spring action
* Tri-Clamp[®] is a registered Trademark of Alfa Laval Inc.

Positioner / Controller

<input type="checkbox"/> Type 1067 - 3-wire	<input type="checkbox"/> Type 8630 - 3-wire	<input type="checkbox"/> Type 8635 - 2-wire
<input type="checkbox"/> Valve mounted <input type="checkbox"/> Remote version		<input type="checkbox"/> Standard <input type="checkbox"/> ATEX/FM Zone 1 <input type="checkbox"/> Zone 2/22
Power supply 24 VDC	Power supply 24 VDC	Power supply 24 VDC via setpoint or BUS
Communication Setpoint / feedback analog signal	Communication Setpoint / feedback analog signal or via BUS <input type="checkbox"/> Profibus DP <input type="checkbox"/> DeviceNet	Communication Setpoint / feedback analog signal or via BUS <input type="checkbox"/> Profibus PA
<input type="checkbox"/> Positioner version Input 0/4 - 20 mA / 0-10 V Feedback <input type="checkbox"/> 4 - 20 mA or <input type="checkbox"/> Binary	<input type="checkbox"/> Positioner version Input 0/4 - 20 mA / 0-5/10 V Feedback <input type="checkbox"/> 4 - 20 mA or/and <input type="checkbox"/> Binary	<input type="checkbox"/> Positioner version Input 4 - 20 mA Feedback <input type="checkbox"/> 4 - 20 mA or/and <input type="checkbox"/> Binary
<input type="checkbox"/> PID Controller version ⁴⁾ Input measuring signal 4 - 20 mA	<input type="checkbox"/> PID Controller version ⁴⁾ Input measuring signal 4 - 20 mA / Pt100 / Frequency	<input type="checkbox"/> PID Controller version ⁴⁾ Input measuring signal 4 - 20 mA
	Inductive proximity switch <input type="checkbox"/> 1 <input type="checkbox"/> 2	Inductive proximity switch <input type="checkbox"/> 1 <input type="checkbox"/> 2

⁴⁾ same setpoint for input and feedback signal as for Positioner version

* To find your nearest Bürkert facility, click on the orange box →

www.burkert.com

In case of special application conditions, please consult for advice.

We reserve the right to make technical changes without notice.

0904/2_EU-en_00891900